

EZETROL TOUCH

WALLACE & TIERNAN[®]

MEASURING, CONTROL AND DOSING SYSTEM

Version 1.14 and later



INSTRUCTION MANUAL

NOTICE

Translation of the original instruction.

In some countries, DEPOLOX, OSEC, Barrier, Chem-Ad and Wallace & Tiernan are trademarks of Evoqua, its subsidiaries or affiliated companies. No part of this document may be reproduced in any form (printed, photocopy, microfilm, or any other procedure) or saved, processed, copied, or distributed using electronic data systems - without the express prior written consent of Evoqua Water Technologies GmbH.

All information in this document is considered reliable and corresponds to the generally applicable technical standards. Evoqua assumes no responsibility for the completeness of this information. Users are responsible for making sure that the product is suitable for specific applications. Evoqua assumes no liability for specific or indirect damage or consequential damage arising from the sale, resale or misuse of its products.

Contents

1.	Introduction	5
1.1	Target groups	5
1.2	Structure of the documentation	5
1.3	Conventions.....	5
2.	Safety.....	6
2.1	Intended use.....	6
2.2	General safety instructions	6
2.3	Specific operating phases	7
2.4	Warranty conditions.....	7
2.5	Exclusion of liability	7
3.	Description.....	8
3.1	General.....	8
3.2	Complete system.....	8
3.3	Retrofit kits/extensions	8
3.4	Optional accessories.....	8
3.5	Electronics module	9
3.6	Flow cell.....	18
3.7	Sensors	19
3.8	Technical data	21
4.	Interfaces	25
4.1	USB interface	25
4.2	RS485 interface	25
4.3	Ethernet interface	25
4.4	Modbus TCP interface	28
5.	Installation	35
5.1	Scope of delivery	35
5.2	Transport and storage	35
5.3	Required ambient conditions	35
5.4	Mechanical Installation	35
5.5	Installation of the module	36
5.6	Removing and fitting the housing cover	38
5.7	Installing the optional strainer	38
5.8	Connecting the sample water inlet	38
5.9	Connecting the sample water outlet.....	39
5.10	Sample water extraction options	40
5.11	Installing and connecting sensors, LED glow stick and multi-sensor.....	43
5.12	Electrical installation	44
5.13	Startup.....	46
5.14	Installing retrofit kits/extensions	47
5.15	Shut-down	49
5.16	Renewed start up	49

6.	Operation	50
6.1	Display and control elements	50
6.2	“Measurement” menu field	51
6.3	“System” menu	53
6.4	Web visualization	62
6.5	Firmware update	63
6.6	Calibration.....	64
6.7	Messages, alarms and errors	67
6.8	Errors and remedies.....	70
7.	Maintenance	71
7.1	Maintenance intervals	71
7.2	Maintenance parts set	71
7.3	Checking for leakage.....	71
7.4	Checking and replacing the electrode cleaning sand.....	71
7.5	Cleaning the flow rate monitor and check valve	72
7.6	Cleaning or replacing the optional strainer	72
7.7	Replacing the fuses on the CPU board.....	73
7.8	Replacing the battery.....	73
7.9	Cleaning	73
8.	Spare parts, Accessories and Retrofit kits	74
8.1	Electronics module (module name E02)	74
8.2	Flow cell (module name D02)	75
8.3	Cell body, flow cell	76
8.4	Sensors and extension cables	77
8.5	Accessories.....	78
8.6	Retrofit kits/extensions.....	79
9.	Wiring diagram	80
10.	EC Declaration of Conformity and Certificate.....	84

1. Introduction

1.1 Target groups

This instruction manual provides the information required for installation, operating and maintenance personnel for the installation, operation and maintenance of the Ezetrol touch Measuring, Control and Dosing System. All personnel working with and on the Ezetrol touch must have read and understood the instruction manual, particularly the safety instructions.

1.2 Structure of the documentation

This instruction manual contains important information for the safe, trouble-free and economical operation of the Ezetrol touch. A thorough review of these instructions will help to prevent danger, reduce repair costs and downtimes and increases the reliability and service life of the Ezetrol touch.

The Chapters Installation and Maintenance are intended only for trained and authorized service personnel. These chapters contain important information on the assembly, configuration, start-up, maintenance and repair, which must be performed by this target group.

1.3 Conventions

This instruction manual contains a number of notes with different priorities that are labeled with pictograms.

DANGER

Immediate danger to life and limb! If the situation is not corrected, death or serious injury will result.

WARNING

Danger to life and limb! If the situation is not corrected, death or serious injury can result.

ATTENTION

If this note is not observed, moderate or minor injury or damage to equipment can result.

WARNING

Electrocution hazard.

ATTENTION

Environmental hazard!

Do not throw away or burn the batteries! Batteries must be disposed of at a collection point.

NOTICE

These notes indicate a material risk or provide useful information to make working with the Ezetrol touch easier.

2. Safety

2.1 Intended use

The Ezetrol touch Measuring, Control and Dosing System with installed sensors is designed exclusively for measurement and control tasks during the treatment of water in swimming pools and baths and saline pools.

The operational safety is only guaranteed if the Ezetrol touch is used in accordance with its intended application. The Ezetrol touch may only be used for the purpose defined in the order and under the installation, operating and ambient conditions specified in this instruction manual.

All inspection and maintenance work must be carried out at the specified intervals.

Compliance with the intended use also includes reading this instruction manual and observing all the instructions therein.

The owner/operator of the installation bears sole responsibility for consequences of any use that does not conform with the installation's intended use.



Risk of injury or death!

The Ezetrol touch must not be operated with flammable liquids

2.2 General safety instructions

The manufacturer places great emphasis on safety when working on or with the Ezetrol touch Measuring, Control and Dosing System. This is taken into account, starting with the design of the installation, by the integration of safety features.

Safety regulations

The safety instructions in this documentation must be observed at all times. Additional industry-wide or in-house safety regulations also continue to apply.

Safety instructions on the Ezetrol touch

All safety instructions attached to the Ezetrol touch must be observed. These instructions must always be clearly legible and complete.

State-of-the-art technology

The Ezetrol touch has been constructed in accordance with the technological state-of-the-art and the accepted rules of safety engineering. However, if the Ezetrol touch is used by persons who have not been adequately instructed, danger to the life and limb of such persons or third parties and damage to the unit itself or to other property cannot be ruled out. Work not described in this instruction manual must be performed only by authorized personnel.

Personnel

The operator of the overall system must ensure that only authorized and qualified specialist personnel are permitted to work with and on the Ezetrol touch. "Authorized specialist personnel" are trained, skilled personnel employed by the owner/operator, the manufacturer or, if applicable, the service partner. Work on electrical components must be carried out by qualified electricians.

Spare parts / components

Trouble-free operation of the Ezetrol touch is only guaranteed if original spare parts and components are used in precisely the combination described in this instruction manual. Failure to observe this instruction may lead to malfunctions or damage to the Ezetrol touch.

Extensions and conversions

Any modifications, extensions or conversions to the Ezetrol touch that could impair its safety require the written approval of the manufacturer.

Electrical power

Only qualified electricians or trained personnel supervised by a qualified electrician are permitted to perform any work on electrical components and must do so in accordance with valid electro-technical regulations.

During normal operation, the controller must remain closed. Connect power cables in accordance with the wiring diagram.



Risk of injury or death!

External voltages may still be connected even if the operating voltage is switched off. In the event of a fault in the electrical power supply, switch the Ezetrol touch off immediately.

IT security

The manufacturer offers IT security mechanisms for its products to support secure system operation. We recommend checking on a regular basis to see what information is available regarding IT security developments for your products. Information on this can be found on the Internet. Moreover, for the safe operation of an installation, it is also necessary to integrate the automation components into a holistic IT security concept which comprises the entire system and is in accordance with the state of the art in IT technology. Integrated products from other manufacturers should also be taken into account.

During commissioning of the Ezetrol touch, the factory-configured passwords and user names should be replaced with individual ones and the user administration enabled.

Disposal

Ensure safe and environment-friendly disposal of agents and replacement parts. Dispose of electronic waste in accordance with local and national regulations.

2.3 Specific operating phases

- Never employ any working methods which could affect safety!
- Never operated with flammable liquids.
- The Ezetrol touch may only be operated with the housing closed!
- Inspect the Ezetrol touch at least once daily for externally visible damage and faults! Inform the responsible person/ authority immediately of any detected changes (including any changes in the operating performance)!
- In the event of malfunctions, always switch the electronics module off immediately! Have malfunctions remedied immediately!
- During installation and maintenance work, secure the Ezetrol touch against being switched back on!
- If stipulated, disconnect all parts of the electronics module from the power supply before performing any inspection, maintenance or repair work. Then first test the disconnected components to ensure they do not carry any voltage.
- Never use corrosive cleaning agents (e.g. spirit, scouring agents)!

2.4 Warranty conditions

The following must be observed for compliance with warranty conditions. If any of the conditions are not met, the warranty is void.

- Installation and commissioning by the manufacturer or trained and authorized specialist personnel, e.g. from contracted companies.
- Intended use
- Observation of the operational parameters and settings.
- The unit may only be operated by trained personnel.
- An operating log book must be kept (only in the public sector).
- Only approved calibration chemicals may be used.
- The unit must not be exposed to frost.
- The prescribed maintenance work must be carried out.
- Use of original spare parts.

2.5 Exclusion of liability

We are not liable for any damages incurred during installation or use of these hardware and software components. This applies specifically to trouble-free interaction with the software and hardware components you choose.

We accept no liability for any loss sustained by the buyer (in particular, lost profits, lost information and service interruptions) arising through the use of the Ezetrol touch nor for other damage. You are solely responsible for the installation!

The content of the instruction manual has been checked to make sure that it matches the hardware and software described. Nevertheless, deviations cannot be ruled out, and we therefore assume no liability for full conformity. The details in this instruction manual are checked regularly and any necessary corrections included in subsequent issues.

3. Description

3.1 General

The Ezetrol touch has a modular structure and comprises:

- Electronics module (module name E02)
- Flow cell, pressurized version (module name D02)
- Sensors

Depending on the sensors installed, the Ezetrol touch measures and controls the auxiliary hygiene parameters free chlorine, pH value, ORP (Redox) voltage, conductivity and temperature

As a rule, the water in swimming pools is disinfected by adding chlorine, sodium hypochlorite or non-organic chlorine compounds. Precise dosing is of vital importance here, as disinfection may not be successful if the concentration is too low, whereas excessively high concentrations can lead to odor contamination, corrosion and damage to pipework.

The Ezetrol touch complies with the following standard:

- PWTAG-Swimming Pool Water Treatment and Quality Standard

The addition and presence of so-called “chlorine stabilizers” (isocyanurates) in the pool water, e.g. in public outdoor swimming pools, disturbs chlorine measurement. Chloroisocyanurates are also sold as “organic chlorine products” in the form of fully soluble granulate or poorly soluble tablets. A dosing system controlled by the measurement of excess chlorine can only be operated with these products if the hydrolysis balance, i.e. the concentration of isocyanuric acid, is taken into consideration. If hydrolysis of these organic chlorination agents is incomplete, only the chlorine released by hydrolysis is detected by the chlorine electrode and not the entire quantity (in accordance with the DPD method).

As a result of the integrated process management, the following functions can be realized:

- Measurement of the hygiene parameters and control
- Dosing of disinfectants
- Correction of the pH value
- Dosing of brine
- Limit value monitoring
- Data transfer to higher-level systems
- Integrated safety functions

3.2 Complete system

Part No.	Ezetrol touch
W3T400908	Chlorine sensor and pH sensor
W3T409427	Chlorine sensor and pH sensor on a mounting plate

3.3 Retrofit kits/extensions

Part No.	Designation
W3T391868	Sensor measuring module ORP (Redox)
W3T434521	Sensor measuring module conductivity 60 mS/cm
W3T434592	Sensor measuring module conductivity 600 μ S/cm
W3T391865	4-way mA output card

3.4 Optional accessories

For order numbers, see Chapter 8.

- Strainer (chapter 5.7)
- Booster pump (chapter 5.8)
- Pressure reducing valve (chapter 5.8)
- PVC or PE version, hose and hose connection (chapter 5.8)
- Extension cable for sensors (chapter 5.4)
- Impedance converter for sensors (chapter 5.4)

3.5 Electronics module

3.5.1 Design



Fig. 1 Electronics module

- A Plastic housing with removable housing cover and Motherboard with power supply, terminal strips, electronic components and relays
- B Touchscreen/Display
- C Cable terminal screws

3.5.2 Functions

The Ezetrol touch is used for measurement and control tasks during the treatment of water in swimming pools and baths and saline pools:

- free chlorine
- pH value
- ORP (Redox) voltage
- Conductivity
- Temperature

The following controller outputs are supported:

Controller for	Type	Parameter description	Action
Positioner without feedback	3-point	Positioner wo. Ym	Dosing Cl ₂ Correction pH ↑
Dosing pump with mA-input	2-point	Analog output mA 2P	Dosing Cl ₂ Correction pH ↓ or pH ↑ Correction conductivity ↑
2 dosing pump with mA-input	3-point	Analog output mA 3P	Correction pH ↓ or pH ↑
Motor dosing pump (pulse-duration controller)	2-point	Dosing pump 2P	Dosing Cl ₂ Correction pH ↓ oder pH ↑ Correction conductivity ↑
2 motor dosing pumps (pulse-duration controllers)	3-point	Dosing pump 3P	Correction pH ↓ and pH ↑

Typical applications:

- Measurement and control of chlorine, pH and as an option ORP (Redox) or conductivity in the swimming pool
- Actuation of dosing pumps or chlorine gas metering systems
- Monitoring and raising of alarm if limit values exceeded
- Data visualization
- Data transfer to higher-level systems

For connection to a visualization system, there is an optional 4-way mA output module, an RS485 interface and an Ethernet interface with Modbus TCP and HTTP protocol.

3.5.3 Controller outputs

The electronics module is equipped with an integrated controller for the chlorine value and a controller for the pH value and the conductivity.

- The chlorine value is held constant at the setpoint using PI single feedback closed-loop control.
- The pH value is held constant at the setpoint using proportional control.
- The conductivity is held constant at the setpoint using PI single feedback closed-loop control.

Controller for	Type	Parameter description	Action
Solenoid pump (pulse-frequency controller)	2-point	Solenoid pump 2P	Dosing Cl ₂ Correction pH ↓ or pH ↑ Correction conductivity ↑
2 solenoid pumps (pulse-frequency controllers)	3-point	Solenoid pump 3P	Correction pH ↓ and pH ↑
Dosing contact	2-point	Dosing contact	Dosing Cl ₂ Correction pH ↓ or pH ↑ Correction conductivity ↑

Positioner without feedback

With the selection of the integrated controller for "positioner", for example, it is possible to use chlorine overfeed control in connection with a positioner as an actuator of a chlorine gas dosing system.

2-point pulse-duration controller for dosing pumps

The dosing pump is switched on for the calculated time within an adjustable cycle period T_p (relay contact). The cycle period is mainly determined by the reaction time of the connected system and entered as the cycle period T_p .

Example:

Cycle period $T_p = 100$ s
Output value $Y_{out} = 30\%$
=> Duty cycle 30 s
=> Off-duty cycle 70 s

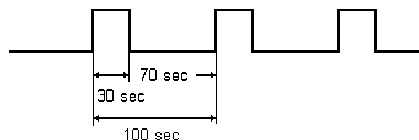

2-point pulse-frequency controller for solenoid pumps

Solenoid pumps are controlled with 0 to 100/120/140/160/180 pulses per minute, depending on the specification of the connected pump. The duty cycle during each dosing is 0.3 s. The pause time is calculated to be between 0.2 s and 60 s, depending on the dosing rate.

Example of a solenoid pump at 120 pulses/min:

Yout in %	Pulses/min
100...	120...
84...	96...
72...	85...
56	75
50...	60...
33...	40...
25...	30...
10...	12...
5...	6...
1	1
0	0

3-point pulse-duration controller for dosing pump and 3-point pulse-frequency controller for solenoid pump

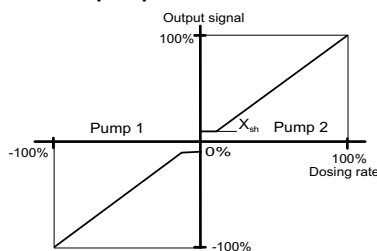

Pump 1 decreases the control value,
Pump 2 increases the control value.

The control range is between -100% (Pump 1) and $+100\%$ (Pump 2); this range can also be set in manual mode. If the setpoint = actual value, no pump is activated (neutral zone X_{sh}). Output signals as for 2 point pulse-duration controller and 2-point pulse-frequency controller.

Analog output controller 2-point

With a control output of 0%, the output current is 0 or 4 mA; with a higher control output, the output current reaches up to 20 mA. Pumps with current input, thyristor control units with DC or AC pumps, or analog control valves can be used as actuators.

Analog output controller 3-point

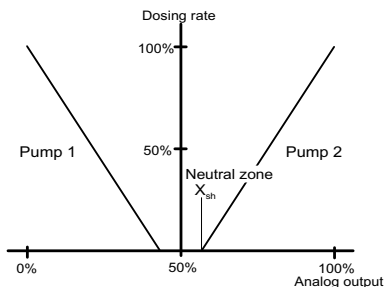

Pump 1 decreases the control value, Pump 2 increases the control value.

Output behaviour is similar to "Analog output controller (2-point)", but with 50 % offset. This means that with a control deviation of 0 % (setpoint = actual value) a current of 10 mA or 12 mA is output (pump is idle). Therefore, two suitable pumps can be actuated with one mA current loop.

Setting	Signal	Pumps
0 to 20 mA	0 to 10 mA	Pump 1
	10 to 20 mA	Pump 2
4 to 20 mA	4 to 12 mA	Pump 1
	12 to 20 mA	Pump 2

Dosing contact

A dosing contact, for example, can be used to actuate electrolysis systems for chlorine dosing. A special controller is required to drive these systems in order to prevent frequent switching on or off (reason: start-up time of electrolysis systems).

The contact is enabled or disabled within the set control parameters.

If the entered setpoint minus hysteresis (e.g. 0.20 mg/l) is not reached, the controller output switches on for at least the minimum duty cycle. The controller output remains switched on as long as the setpoint is not reached.

If the setpoint is exceeded, the controller output switches off immediately (provided that the minimum duty cycle has elapsed).

Renewed activation if the value is below the setpoint hysteresis is only possible when the minimum off-duty cycle has elapsed.

NOTICE

In manual mode, the minimum duty cycle and the minimum off-duty cycle are ignored!

Controller STOP function

When the controller Stop function is active, all controller outputs are switched off (positioner closed, dosing pump off, solenoid pumps off, dosing contact off). Controller Stop is triggered by the digital inputs, e.g. by sample water Stop, circulation off, external Stop.

Standby function

When the Standby function is active, all controller outputs are switched off (positioner closed, dosing pump off, solenoid pumps off, dosing contact off). The function is triggered by the digital input function Standby, which is used when circulation is switched off and no sample water is flowing through the flow cell over an extended period. The measured value display is hidden during Standby.

3.5.4 Control parameters

Control parameters are setting values used to determine the control response of a controller. Different parameters apply depending on the type of controller. Depending on the selection, the different settings menus are displayed. The control parameters are listed alphabetically.

max. pulses/min – Maximum number of pulses

Only applies to solenoid pumps. This parameter is used to set the maximum number of pulses per minute in accordance with the pump used.

Setting range: 100/120/140/160/180 pulses

Setpoint

Specified value at which the control value (chlorine, pH, conductivity) can be maintained by the controller.

Setting range: Corresponds to the respective measuring range.

Tn – Integral action time (I-element) of the PI controller

On the basis of the integral action time Tn, the dosing rate changes constantly until the setpoint is reached. The higher the value of Tn, the longer it takes until the controller increases the dosing rate.

Tn higher: Control response is slower
Tn lower: Control response is faster

Setting range: 0 to 100 min (Tn = 0 means that the "I-element" is deactivated, i.e. a pure P-control response applies). It may not be possible to reach the setpoint value.

Tp – Cycle period

Only applies to dosing pumps. The cycle period Tp defines a switching period, which must be coordinated with the respective pump type.

Setting range: 10 to 180 s

Example:

Fast dosing pumps can be actuated by a low Tp, slow dosing pumps can be actuated by a high Tp. The control parameter Tp must always be adjusted to suit the dosing pump used:

Dosing pump strokes/min	Tp value
to 20	120
20 to 40	100
40 to 80	60
80 to 125	30
125 to 200	15

Ts – Loop rise time

Time required to reach the end value of the measuring range with 100 % dosing rate. This time is defined automatically by the system for automatic tuning, but it can also be entered manually.

Setting range: 1.0 to 480.0 min

Tu – Loop dead time

Time required between start of dosing and clear recognition of an increase in the measured value. This time is defined automatically by the system for automatic tuning, but it can also be entered manually.

Setting range: 1.0 to 60 min

NOTICE

If the Tu and Ts values are modified manually, the control parameters Xp and Tn are re-calculated.

Ty – Running time of the positioner

Only applies to positioners. Ty is the time the positioner requires to adjust from 0 % to 100 %.

Setting range: 10 to 180 s

Control direc. – Control direction

Defines which medium is used to perform the correction. Only for 2-point control for pH.

Setting range: Acid / Alkali for pH control

Example pH:

for control direction "Acid" => lower pH value when adding acid

Xp – Proportional factor of the PI controller

The control amplification is determined by means of the proportional factor. The lower the proportional factor Xp is selected in %, the greater the deviation from the setpoint is amplified, and the more quickly the controller attempts to control the deviation from the setpoint. The control amplification factor is calculated using the following equation: Factor = $(1/Xp) \times 100 \%$

Setting range: 1 % (factor 100) to 1000 % (factor 0.1)

Xsh – Neutral zone

Only applies to 3-point controllers. There is no control output within the neutral zone.

Setting range: 1 to 5 % (based on the measuring range)

3.5.5 Alarms

The electronics module supports up to eight freely configurable alarms. The alarms can be assigned to a relay contact and noted on the color display. At the same time, a message is displayed in the message window and the message system is displayed. The number of available relays depends on the configuration. A maximum of six alarm relays are possible, depending on if the controller disinfection output is used. The alarm relays can be used, for example, for safety deactivation of dosing when specific values are exceeded or not reached. Each alarm can be assigned the following functions. Multiple assignment is possible:

Limit value Min 1 and Min 2	=>	all measuring values can be selected individually
Limit value Max 1 und Max 2	=>	1 to 5 can be selected individually
Digital inputs	=>	1 to 5 can be selected individually
Error		

Acknowledgment “none”

- The alarm symbol and the message symbol light up in the event of an alarm and go out automatically when the condition is eliminated.
- Unlatched alarms are displayed in yellow as messages.
- The relay is active when the alarm symbol is displayed and the alarm is active.

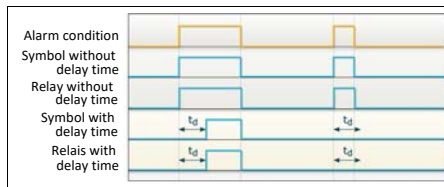

Fig. 2 Acknowledgment “none”

Acknowledgment “ACK with reset”

- In the event of an alarm, the alarm symbol and the message symbol flash and the relay is active until acknowledged.
- The alarm symbol and the message go out even if the conditions still apply when the alarm is acknowledged.
- Latched alarms are displayed in red as messages.
- The relay becomes inactive after acknowledgment if the condition is still pending.

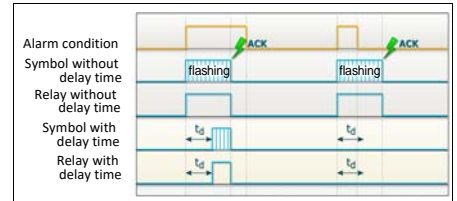

Fig. 3 Acknowledgment “ACK with reset”

Acknowledgment “simple ACK”

- The relay becomes active as soon as the alarm is active.
- In the event of an alarm, the alarm symbol and the message symbol flash until the alarm is acknowledged.
- If the condition is no longer present when the alarm is acknowledged, the alarm symbol goes out and the message disappears.
- If the condition is still present when the alarm is acknowledged, the alarm symbol and the message are reset from flashing to a permanent state. The alarm symbol and the message light up until the condition is eliminated (auto-reset).
- Latched alarms are displayed in red as messages.
- The relay is only deactivated when the condition has been eliminated and acknowledged.

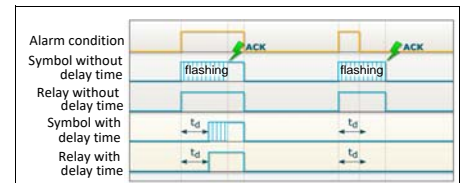
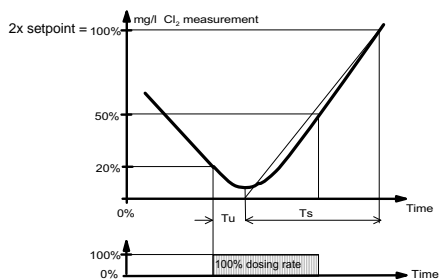

Fig. 4 Acknowledgment “simple ACK”

3.5.6 Auto tune (only applies to free chlorine)

The electronics module is equipped with an Auto tune function to facilitate commissioning and optimize operation. The Auto tune program automatically determines the control parameters X_p and T_n for free chlorine control.



NOTICE

The control parameters X_p and T_n determined by the Auto tune program must be considered as a recommendation for first commissioning! The control parameters X_p and T_n can be optimized manually to ensure maximum control quality.

The following requirements must be met:

- pH value stably controlled and at the setpoint.
- Positioner set to automatic (manual wheel engaged)
- Dosing pump set to automatic
- Calibrated chlorine measurement (zero point and DPD value)
- Loop dead time < 60 min
- Loop rise time < 480 min (8 h) for 0 to 100 % measurement range
- Decomposition time < 480 min (8 h) of the current measuring value to 20 % of the 2x setpoint
- Correct menu setting of the end value, control direction (direct or inverse), actuator (e.g. positioner), positioner running time.

Auto tune must not be started:

- if a large volume of fresh water is being added
- if the measuring cell has not been run in
- during cleaning work
- during filter backwashing
- while the circulation changes
- during peak chlorination

Starting Auto tune

- 1 Switch to the main view.
- 2 Press the measurement “Chlorine” menu field.
- 3 Press the  symbol.
- 4 Press “Auto tune.” The loop parameters T_u and T_s are displayed.
- 5 Press the “Start” button. The current phase (13 in total) of Auto tune is displayed.
- 6 Confirm successful Auto tune with “Auto tune OK.”
- 7 Press the Home key to return to the main view.

Error message during Auto tune

If Auto tune is not successful, the error message “AUTO TUNE?” is displayed. The reason for this may be problems with the dosing system or loop times. Errors must be rectified in order to carry out the Auto tune function. See “Completing Auto tune with errors” on page 15.

Various status messages can be read off, depending on the selection of the actuator. Different status messages also have different execution times. Some status messages may only be displayed briefly or not at all if the execution time is very short.

Auto tune sequence

Each Auto tune phase is now displayed with a status message:

Display text	Explanation
1: Initialization	Start
2: Control signal $Y_m = 0\%$	Chlorinator to 0% or dosing pump off
3: Wait for act. value $X = 20\%$	Delay until act. value $< 0.2 \times 2 \times \text{setpoint}$
4: Set control signal 100%	Chlorinator to 100% or dosing pump on
5: Wait for control signal 100%	Wait until chlorinator reaches 100%
6: Init. dead time measurement T_u	Start dead time measurement
7: Dead time measurement T_u	Measurement of the loop dead time T_u
8: Check dead time T_u	Plausibility enquiry dead time
9: Calculate initial values T_s	Start of rise time measurement
10: Measure rise time T_s	Measurement of the loop rise time T_s
11: Calculate parameter	Calculate control parameters
12: Set control signal $Y = 0\%$	Chlorinator to 0% or dosing pump off
13: Wait for control signal 0%	Wait until chlorinator reaches 0%

ATTENTION

Auto tune can take up to 13 hours, depending on the control loop. During this time no errors should occur on the control loop (e.g. filter backwashing, changes in the circulation speed or widely fluctuating number of visitors to the pool).

NOTICE

To monitor the determined loop times, they are entered in the "Tu" and "Ts" menus. If any errors in the control loop do occur during Auto tune (e.g. filter backwash or changes in the circulation speed), this may lead to incorrect loop times, resulting in the determination of incorrect control parameters.

NOTICE

The Auto tune procedure can be terminated at any time with "ABORT." The previously set parameters remain unchanged.

ATTENTION

The remaining control parameters are not influenced when Auto tune is performed.

Completing Auto tune without errors

When the loop times (dead time T_u and rise time T_s) have been completed without error, calculation of the control parameters X_p and T_n commences. This is shown by "AUTO TUNE OK." The calculated parameters are entered in the menus. When Auto tune has been completed, the measuring amplifier adjusts with the newly calculated control parameters and continues in the selected operating mode (e.g. automatic).

Completing Auto tune with errors

If errors occur in the control loop during Auto tune (e.g. filter backwashing, changes in the circulation speed or widely fluctuating number of visitors to the pool) or if the reaction times of the control loop are too long, Auto tune is interrupted.

NOTICE

If any of the error conditions described below occur, Auto tune is interrupted. The measuring amplifier displays a fault message. The original parameters X_p , T_n , T_u and T_s are not changed. The message must be acknowledged, the controller continues to operate with the previous settings.

Possible error conditions:

- **Initial value not reached (display: "T = > 8h")**
When Auto tune has started and the dosing system has closed or the dosing pump has switched off, the measuring amplifier waits until the actual value has dropped below the initial value (0.2 x the measurement range value). This delay is indicated by "2: X = 20 %" on the display and must not exceed 8 hours.
- **Loop dead time too long (display: "Tu = > 1h")**
The value determined by the time measurement between start-up of the dosing system, switch-on of the dosing pump and the rise of the actual value must not exceed 1 hour. This measured time is displayed by "6: Tu!" on the display.
- **Loop rise time too long (display: "Ts = > 8h")**
The time required by the control loop to increase the actual value to 50 % of the measuring range at a 100 % dosing rate of the dosing system or the dosing pump. This measurement is indicated with "9: Ts!" on the display and must not take more than 4 hours.

Determination of the control parameters with known Tu and Ts times

If the loop times Tu and Ts are already known or if these cannot be determined automatically due to specific system conditions, the loop times can be entered in the "Tu" and "Ts" menus. When Tu or Ts are saved, the control parameters Xp and Tn are also calculated and entered in the menus.

3.5.7 Safety functions

The electronics module is equipped with various integrated safety functions to ensure system safety and minimize the risk of accidents. The following safety functions are integrated:

- Cl₂ feed lockout activated if the circulation fails and/or if the dosing tank signals that it is empty and also if the sample water supply fails (depending on the configuration of the digital inputs)
- Maximum dosing time monitoring and the feed time delay (configurable)
- Alarms freely configurable
- External STOP for all controllers (depending on the configuration of the digital inputs)
- "Positioner closed" function in the event of a power failure (only if actuator has external power supply)
- If the pH value deviates too greatly from the pH setpoint, Cl₂ feed lockout switches chlorine dosing off
- Password protection with three levels
- Safety MAN. mode stops dosing with sample water stop or external stop

Sample water monitoring**Risk of injury or death!**

If there is a shortage of sample water or the flow rate is too low, there is a risk of uncontrolled dosing of chemicals. To ensure safe operation and prevent injury, the sample water monitoring must never be disabled. Never disable the sample water monitoring - even temporarily, e.g. by bridging the signal input.

The sample water monitoring must be checked regularly. Without automatic detection of a shortage of sample water or an excessively low flow rate, there is a risk of uncontrolled dosing of chemicals. The sample water monitoring deactivates dosing if there is a shortage of sample water and prevents the uncontrolled dosing of chemicals.

Circulation monitoring

DANGER

Risk of injury or death!

A circulation monitoring device must be installed in the unit and connected to the electronics module. Chemical dosing must switch off if the circulation is switched off or the circulation rate is too low. To ensure safe operation and prevent injury, it is essential to install circulation monitoring

The circulation monitoring must be checked regularly. The input used must be configured as "Controller Stop." The dosing of chemicals must switch off if the circulation is deactivated or the circulation output is too low, e.g. dosing switches off with digital input 2 used as "Controller Stop."

3.5.8 Digital inputs

There are five integrated digital inputs on the CPU-board of the electronics module. They are provided for connection of voltage-free contacts (< 100 Ohm) and are supplied internally with 24 V.



WARNING

Do not apply voltages at the digital input terminals!

The functions of the digital inputs can be configured for the specific customer application in the "Input/Output" menu. Digital input 1 is used for sample water monitoring and cannot be changed.

Digital input DI 1

With the help of the voltage-free contact of the flow rate monitor on the flow fitting, the controllers can be influenced:

- Before expiry of the sample water monitoring delay time (0 to max. 10 min.):
The chlorine dosing pump and the dosing pump for pH correction continue dosing at the same rate.
The positioner remains unaffected.
The  symbol on the display flashes.
Display: 
- After expiry of the sample water monitoring delay time:
The chlorine dosing pump and the dosing pump for pH correction are switched off.
The positioner moves to 0 %.
Display: 

NOTICE

Controller switch-off is only effective in "Safety MAN. mode".

Digital input DI 2 to DI 5

Various functions can be assigned to the digital inputs. With the help of a voltage-free enabling contact, e.g. circulation off, the controllers can be stopped immediately:

- The chlorine dosing pump and the dosing pump for pH correction are switched off.
The positioner moves to 0 %.
Display:  2 (example)

NOTICE

Controller switch-off is only effective in "Safety MAN. mode".

- Empty signal contact of the chemical tank(s).
The chlorine dosing pump and the dosing pump for pH correction are switched off.
The positioner moves to 0 %.
Display:  3 (example)
- Cl₂/pH tank monitoring
If the Cl₂/pH tank monitoring is activated, DI 3 to DI 5 are used for connection of the chlorine and pH suction lances. At minimum fill level, a message is generated for each tank, and if one of the two tanks is empty, chlorine and pH dosing switches off.
- Standby function
When the Standby function is activated, all controllers are switched off and dosing is deactivated. The alarms are disabled. Measured value displays are hidden. This function is used to switch off the measuring and control system when circulation and the sample water are switched off simultaneously.

NOTICE

When the contact closes, restart of the controller may be delayed due to the dosing delay time. In as-delivered status, the digital inputs are disabled. To activate the function, connect an external contact and configure the digital input in the menu. The digital inputs can also be assigned as alarms.

3.5.9 Relay outputs

The electronics module has a maximum of six relays, each with a changeover contact. These switches are assigned various switching tasks depending on the respective application. The corresponding diagrams are defined in chapter 9. "Wiring diagrams".

The connection and switching of non-permissible loads / loads destroys the relay contacts. The device works uncontrollably as a result!

In order to switch inductive loads or larger capacitive loads, which exceed the technical characteristics of the relay contact, an additional switching element must be installed. For example a contactor or load relay with suitable specification. Relay contact details see chapter 3.8 "Technical Data" - Relay outputs. To protect radio interference suppression, the relay contacts are protected internally by suppressor diodes. Relay outputs are protected by fuses. They act as overcurrent limiters protecting the terminal and relay connections. The fuses are replaceable. Spare fuses see chapter 8.

NOTICE

When using internal power (L1 and N/L2) for power supply of dosing machines or external devices the power consumption must not be higher than 6 A in total.

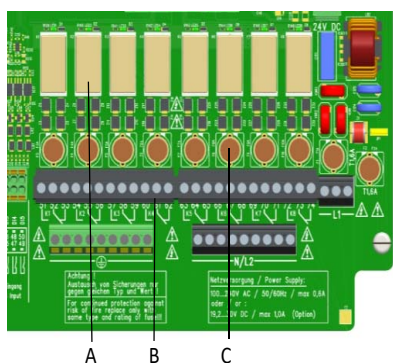

Fig. 5 Detail of PCB - relay outputs

- A Relay
- B Terminal strips
- C Fuses

3.5.10 Interfaces

The interfaces are described in detail in chapter 4. The following interfaces are available:

- USB interface
- RS485 interface
- Ethernet interface
- Modbus TCP interface

3.6 Flow cell

3.6.1 Design

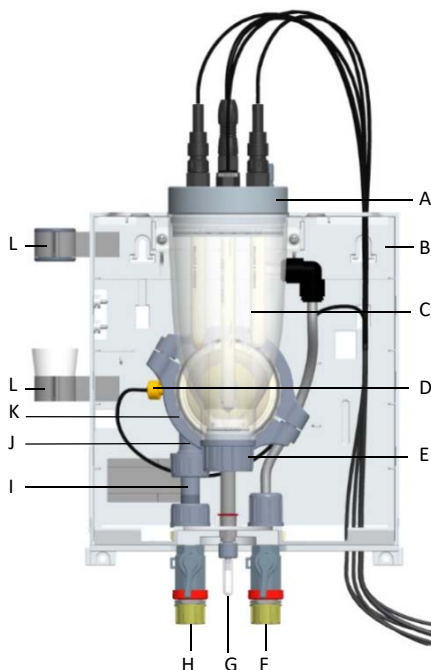

Fig. 6 Cross-section, flow cell

- A Cover to hold the sensors and LED glow stick (cell body cover)
- B Plastic housing with removable housing cover
- C Cell body
- D Multi-sensor
- E Flow distributor cap
- F Sample water outlet with ball valve
- G Sample extraction unit (drain)
- H Sample water inlet with ball valve
- I Filter unit without fine filter
- J Check valve housing
- K Flow control valve
- L Calibration holding clips

3.6.2 Function

The following section describes the functional principle of the flow cell from the sample water inlet to the sample water outlet.

The sample water supply is connected on the input side via the G1/2" connection to the ball valve. The input pressure must be around 0.25 to 3.0 bar. To guarantee a constant flow, the minimum input pressure must not be less than 0.25 bar. If the pressure is lower, an optional booster pump must be used. If the admission pressure exceeds 3.0 bar, an optional pressure reducing valve must be used.

The sample water flows over the optional strainer, which prevents dirt particles penetrating into the flow cell. In the direction of flow, the sample water flows via the filter unit to the check valve housing. The check valve housing offers a non-return function and guides the ball for flow rate monitoring.

The multi-sensor monitors the correct flow following the float principle with reed switch and records the temperature with a Pt1000 sensor. Large-area sample water earthing is via the stainless steel sensor housing.

The flow control valve ensures a flow of the sample water that is not dependent on the operating pressure. The correct sample water flow of 33 l/h is preset, checked and documented at the factory.

The cell body, which can be illuminated, holds the sensors and due to its design, offers good cleaning and service options. The sensors are installed in the mount hole in the cell body cover with standardized threaded connections or in special sensor holders. The LED glow stick is installed in the cell body cover to visually monitor the sensors and to signal messages and errors in color.

The flow distributor cap screwed into the cell body from the bottom allows continuous hydro-mechanical cleaning of the electrode of the chlorine sensor using special cleaning sand and thereby effectively prevents the natural contamination of the electrode surfaces.

Clean electrode surfaces and a constant flow of sample water are decisive criteria for high-quality chlorine measurement and quick responsiveness.

The sample water supply is connected on the output side via the G1/2" connection to ball valve.

At this point, a maximum back pressure of 1.5 bar is permitted.

A sample extraction unit is used to draw sample water from the cell body through the low-pressure side of the flow control valve or to drain the cell body for servicing purposes.

3.7 Sensors

The sensors are screwed into the cover of the flow cell and connected to the electronics module.

3.7.1 Chlorine sensor

The chlorine sensor consists of an amperometric 3-electrode systems with potentiostatic connection. The free chlorine reacts at the working electrode (cathode) and a current proportional to the chlorine concentration is measured. The chlorine sensor consists of the measurement or working electrode, the counter electrode and a reference electrode. The potentiostatic connection maintains the potential between working electrode and reference electrode at the level necessary for the reaction. The current flows via the counter electrode. This measurement method ensures a precise and reproducible reading and a stable zero point. The reference electrode is a silver/silver chloride electrode (Ag/AgCl) that remains de-energized. The electrolyte is a saturated potassium chloride solution. A membrane permeable for the electrolyte provides the electrical connection to the measuring solution. Direct contact with the sample water to be examined can lead to inactivation of the electrode surfaces as a result of dirt deposits or electrochemical side reactions. The flow of sample water in the flow cell ensures continuous cleaning of the electrodes with a special cleaning sand. Turbulence ensures constant contact of the cleaning particles with the surfaces of the electrodes and keeps them free of contamination. In as-delivered status, the chlorine sensor is equipped with a watering cap over the electrodes and the membrane. It contains diluted potassium chlorine solution which keeps the membrane moistened, ensuring that the chlorine sensor is ready for immediate use. When the chlorine sensor is not in use, for example during the winter, we recommend fitting the watering cap, filled with diluted potassium chloride solution.

3.7.2 pH sensor

The pH sensor consists of a pH combination electrode. The glass electrode is the most powerful sensor for pH measurement, with a working range that covers almost the entire pH spectrum. The pH-sensitive element is the membrane made of special silicate glass, a rounded tip at the lower end of the pH sensor. The reference electrode is a silver/silver chloride electrode (Ag/AgCl) and, together with the pH electrode, forms the measuring chain. The reference electrode is the stable electrical reference point for voltage measurement.

The electrolyte is a saturated potassium chloride solution. As the chloride concentration of the electrolyte remains almost constant, the potential of the reference electrode is also constant. Salt rings as an additional salt depot further increase the service life of the pH sensor. A ceramic membrane permeable for the electrolyte provides the electrical connection to the measuring solution. This ceramic membrane is particularly suitable for the treatment of drinking water and water in swimming pools and baths, as the electrolyte can only flow slowly through the pores of the ceramic pin, thus ensuring very long service life for the entire measuring chain.

The pH sensor is plugged in an electrolyte container with diluted electrolyte which protects the sensitive membrane, keeps the membrane moist and thus ensures that the measuring cell is ready for immediate use. When the pH sensor is not in use, for example during the winter, we recommend storing it in the transport container in diluted electrolyte.

3.7.3 OPR (Redox) sensor

The ORP sensor consists of a ORP combination electrode. The ORP sensor consists of a glass shaft with a platinum or gold tip fused into its lower end.

Together with a silver/silver chloride electrode (Ag/AgCl) as a reference electrode, it forms a measuring chain. The task of the reference electrode is to provide a constant potential during potentiometric measurements. This potential is measured against the potential of the metal electrode. The electrolyte is a saturated potassium chloride solution.

As the chloride concentration of the electrolyte remains almost constant, the potential of the reference electrode is also constant. Salt rings as an additional salt depot further increase the service life of the ORP sensor.

A ceramic membrane permeable for the electrolyte provides the electrical connection to the measuring solution. This ceramic membrane is particularly suitable for the treatment of drinking water and water in swimming pools and baths, as the electrolyte can only flow slowly through the pores of the ceramic pin, thus ensuring very long service life for the entire measuring chain.

The ORP sensor is plugged in an electrolyte container with diluted electrolyte which protects the sensitive membrane, keeps the membrane moist and thus ensures that the measuring cell is ready for immediate use. When the ORP sensor is not in use, for example during the winter, we recommend storing it in the transport container in diluted electrolyte.

The following reference values apply for quick and complete disinfection of the water in swimming pools and baths:

fresh water	
pH 6.5 to 7.3	UG > 750 mV
pH 7.3 to 7.6	UG > 770 mV

3.7.4 Conductivity sensor

The conductivity sensor comprises a 4-electrode system with integrated temperature sensor. The shaft of the measuring cell is made of epoxy, ensuring high durability. The electrodes are made of graphite. The conductivity of the medium is determined by means of voltage and current measurement. The sensor is ready for use. In preparation for winter, the sensor must be flushed (e.g. with distilled water) and can be stored dry. It is installed either loose in a non-pressurized flow cell or with a clamp connection in a pressurized flow cell.

3.8 Technical data

3.8.1 Electronics module (module name E02)

Housing	Dimensions (WxHxD)	12.6" x 12.2" x 6" (320 x 311 x 153 mm)
	Weight	approx. 7.7 lbs (3.5 kg)
	Protection rating	IP66
	Mains connection	100 to 240 V AC \pm 10%, 50 to 60 Hz, 15 W
Display	4.3" graphic color display with LED backlighting and capacitive touch-screen behind shatterproof glass panel, resolution 480x272 pixels	
Insulation	Overvoltage category	2
	Contamination level	2
	Protection category	1
Operating conditions	Ambient temperature	32°F to 122°F (0 to 50 °C)
	Humidity	< 80 %, non-condensing
	Environment	No direct sunlight
	Atmospheric pressure	22.14 to 31.30 in Hg (75 to 106 kPa)
	Max. working height (altitude)	2000 m
	Storage temperature	-4°F to 158 °F (-20 to +70 °C)
	Noise emission	<45 dB
Digital inputs	5x for voltage-free contact (internal 24 V power supply); Freely selectable function in menu; When input open: DI active; When input closed: DI inactive	
Measurement inputs	Free chlorine for 3-electrode sensor (measuring range 0 to max. 10 mg/l, end value can be set); pH value (measuring range pH 0 to pH14, initial and end value can be set); ORP voltage (measuring range 0 to max. 1000 mV, initial and end value can be set); Conductivity (measuring range 0 to max. 300 mS/cm) end value can be set; Temperature (measuring range 0 to 50 °C/32 to 122 °F)	
Relay outputs	Type	6x changeover contact with integrated fuse, replaceable, type TR5 3,15 A T
	High nominal breaking	5A 250V AC, 1250VA max. (resistive load) 1A 250V AC, 250VA max. (cos ϕ = 0,4) 5A 30V DC, 150W max. (resistive load)
	Switching voltage max.	250V AC / 125V DC
	Switching current max.	5A AC / DC
	UL/CSA-rating	5A, 125/250V AC (general use) 1/6HP 125, 250V AC 5A 30V DC (resistive) 30W max., 1A, 30V DC – 0.24A, 125V DC (inductive) B300

NOTICE

When connecting inductive or capacitive loads (e.g. pump with integrated switching power supply), an additional power relay with suitable specification must be provided. Each relay output has an integrated 3.15 A fuse as overcurrent protection.
 Typical use of relays: enable contact for dosing device, control of motors or dosing pumps.

Analog outputs	4-way mA output card 0/4 to 20 mA (optional); Freely configurable signal assignment; Load max. 500 ohm, accuracy < 0.5 % FS ; Galv. isolated up to 50 V relative to earth
Interfaces	RS485 interface with Wallace & Tiernan protocol for connection to OPC server, Process Monitoring System or control system for data visualization; Ethernet interface (HTTP protocol/Modbus TCP protocol); USB interface for firmware update

3.8.2 Flow cell (module name D02)

Housing	Dimensions (WxHxD)	9.96" x 14.76" x 6.42" (253 x 375 x 163 mm)
	Weight	approx. 5.5 lbs (2.5 kg)
Connections	Pressurized version	Inlet and outlet: G 1/2" A thread connection
Flow control valve	Sample water flow	0.15 gpm (33 l/h), controlled, preset at the factory
	Flow control range	4 to 45 psig (0.25 to 3.0 bar)
	Back pressure	Pressurized version: max. 22 psig (1.5 bar)
Multi-sensor	Switching point	5.5 gal/hr \pm 0.8 gal/hr (21 l/h \pm 3 l/h)
	Switching hysteresis	0.53 gal/hr (2 l/h)
	Temperature sensor	Pt1000
Operating conditions	Water quality	Brine and pool water acc. to standard
	Storage temperature	-4 to 158 °F (-20 to +70°C)

3.8.3 Sensors

NOTICE

When disinfecting with inline electrolysis systems or hydrogen drainage into the pool water, the gold version of the chlorine or ORP (Redox) sensor must be used.

Chlorine sensor	platinum version (W3T160652)	gold version (W3T160991)
Version	Amperometric 3-electrode sensor with platinum electrodes, salt reserve, zirconium dioxide diaphragm, polymerized solid electrolyte, Ag/AgCl reference electrode	Amperometric 3-electrode sensor with gold electrodes, salt reserve, zirconium dioxide diaphragm, polymerized solid electrolyte, Ag/AgCl reference electrode
Measurement range	0 bis 50 mg/l Cl ₂	
Working temperature range	-5 to +80°C (23 to 176°F)	
Operating pressure	0 to 6 bar (6 x 10 ⁵ Pa)	
Minimum conductivity of the sample water	50 µS/cm	
Installation length	165 mm	
Screw-in thread	PG 13,5	
Storage temperature	-5 to +30°C (23 to 86°F)	

ORP (Redox) sensor	platinum version (W3T169298)	gold version (W3T172356)
Version	Combination electrode with platinum electrode, salt reserve, zirconium dioxide diaphragm, polymerized solid electrolyte, Ag/AgCl reference electrode	Combination electrode with gold electrode, salt reserve, zirconium dioxide diaphragm, polymerized solid electrolyte, Ag/AgCl reference electrode
Measurement range	±2000 mV	
Working temperature range	23 to 176°F (-5 to +80°C)	
Operating pressure	0 to 6 bar (6 x 10 ⁵ Pa)	
Minimum conductivity of the sample water	50 µS/cm	
Installation length	120 mm	
Screw-in thread	PG 13.5	
Storage temperature	-5 to +30°C (23 to 86°F)	

pH sensor (W3T169297)	
Version	combination electrode with universal membrane glass, salt reserve, zirconium dioxide diaphragm, polymerized solid electrolyte, Ag/AgCl reference electrode
Measurement range	pH 0 to 12 (temporarily to pH 14)
Working temperature range	23 to 176°F (-5 to +80°C)
Operating pressure	6×10^5 Pa (0 to 6 bar)
Minimum conductivity of the sample water	50 μ S/cm
Installation length	4.72" (120 mm)
Screw-in thread	PG 13.5
Storage temperature	23 to 86°F (-5 to +30°C)

Conductivity sensor (W3T172052)	
Version	4-electrode measurement, integrated temperature sensor NTC 30, graphite electrodes, epoxy shaf
Measurement range	1 μ S/cm to 2 S/cm
Cell constant	$0,475 \text{ cm}^{-1} \pm 1,5\%$
Working temperature range	-5 to +100°C (23 to 212°F)
Operating pressure	0 to 10 bar (1×10^6 Pa)
Installation length	120 mm
Insert	Loose or pressurized with clamp connection
Enclosure	IP 67 (in plugged in state)
Storage temperature	0 to +50°C (32 to 122°F), store in the fresh air

4. Interfaces



Risk of injury or death!

External voltages may still be connected even if the operating voltage is switched off.

4.1 USB interface

The electronics module is equipped internally with a USB interface. It is used to update the firmware via USB stick (chapter 6.5) or for use as a data logger via USB stick.

If a memory stick (W2T866279) is permanently installed in the USB port, monthly archive files are saved in CSV format. All measurements, controller outputs and states of the digital inputs are saved every two minutes. Proceed as follows to create data backup:

- 1 De-energize the electronics module.
- 2 Remove the housing cover.
- 3 Remove the USB stick.
- 4 Copy the archive files.
- 5 Reinsert the USB stick.
- 6 Fit the housing cover again.
- 7 Switch the electronics module on again.



Fig. 1 Detail of PCB - USB interface

4.2 RS485 interface

The RS485 interface is used for data transfer to higher-level control systems such as the Process Monitoring system or other systems that support the Wallace & Tiernan RS485 protocol. For more detailed information, please refer to the instruction manual “RS485 interface.” You can request this instruction manual from us or download it from our homepage. The RS485 interface is electrically isolated. It has four integrated terminals, a terminating resistor R_t and balancing resistors R_u and R_d for incorporation into a Wallace & Tiernan bus system.

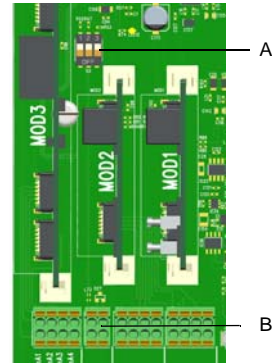

Fig. 2 Detail of PCB - RS485 interface

- A DIP switches for activating the resistors:
 DIP switch 1 (left): Balancing resistor R_u
 DIP switch 2 (center): Terminating resistor R_t
 DIP switch 3 (right): Balancing resistor R_d
- B Terminals, RS485 interface

4.3 Ethernet interface

The electronics module has two integrated Ethernet interfaces (ETH 1 and ETH 2). They are connected internally via an Ethernet switch. The device has an MAC address. The MAC address is displayed in the menu “Information”. The installed LAN interface allows data visualization via an Internet-capable device and HTTP protocol or standard browser. The LAN interface also supports data communication via the Modbus TCP protocol, (chapter 4.4).

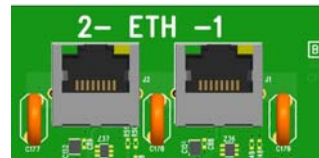

Fig. 3 Detail of PCB - Ethernet interface

Visualization and operation are effected via the web pages integrated in the electronics module. Wireless access via mobile devices such as tablet computers or smartphones is possible by installing a wireless router on-site and connecting it to the electronics module. The Ethernet-interface supports a transmission rate of 10 or 100 Mbit/s. There are two integrated Ethernet connections.

The integrated 2-port switch replaces additional external switch assemblies. To avoid long process times, we recommend that you do not daisy-chain more than three devices via the internal switch. An additional external switch assembly must be provided if several devices are used.

Connection is via a standard Ethernet connection cable. Two special M25 cable glands with slit rubber seals and larger grommets are installed to allow the use of pre-terminated Ethernet cables with connectors. The Ethernet connectors can be inserted through these fittings.

NOTICE

This instruction manual does not cover installation and commissioning in combination with routers or wireless routers. Responsibility for this lies with the operator.

NOTICE

- For security reasons, access to the device should only be granted to authorized personnel.
- Permanent, unsafe connections via the Internet or WLAN are not permitted. Safe connections can, for example, be set up via a VPN-secured communication channel or an encoded WLAN connection.
- The electronics module only supports the unencrypted communication protocol "http" and is designed for operation within an Intranet (closed network), chapter 2.2 "IT safety".

The Ethernet connection is designed in accordance with IEEE 802.3. There are two I8P8C sockets (often referred to as RJ45 sockets) installed. Connection to the HUB or switch can be realized with a 1:1-wire and screened patch cable. Direct connection to a PC network card is possible using a patch cable (1:1) or a cross-over cable (crossed network cable). The LEDs are fitted in the 8P8C socket. They display the interface statuses.

Meaning of the LED:

- **green lights up:** Ethernet connection established
- **green flashes:** Data being transferred
- **yellow off:** 10 Base-T
- **yellow lights up:** 100 Base-T

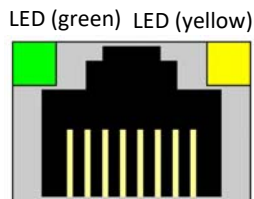

Fig. 4 Ethernet connection

The connection runs in Auto negotiation mode. The data transfer rate and full or half duplex are defined automatically with the connected switch/HUB.

4.3.1 Configuring the Ethernet connection for installation in a network

The electronics module is delivered with a fixed IP address. Alternatively, the electronics module can be configured with DHCP. The Ethernet settings of the electronics module can be configured via the menu "Settings" – "Network". The MAC address is displayed in the "Information" menu.

A network connection is set up between a PC or laptop computer with Ethernet interface (10/100 MB/sec) and the electronics module. In order to operate the electronics module in a network, the network configuration must be adapted to the existing network. If required, you can obtain the necessary information (IP address, subnet mask) from your local network administrator. You can configure the IP address and subnet mask assigned to you in the menu "Settings" - "Network".

NOTICE

A network connection or connection via WLAN router is required in order to access the web views of the Ezetrol touch.

Ezetrol touch factory settings

IP address	192.168.200.11
Network mask	255.255.255.0
Gateway	0.0.0.0

Web view in the browser:

- 1 Start the browser, e.g. Firefox or Internet Explorer.
- 2 Enter the IP address of the electronics module, e.g. "http://192.168.200.11/" (in the factory setting). After successful connection, the start screen of the electronics module appears. Depending on the resolution of the operating Ezetrol touch, the measurement windows are displayed side by side or one below the other. The current value, range, setpoint and limit values as arrows are displayed for each measurement. The operation mode and dosing output for the available controllers are also displayed.

4.3.2 Configuring direct network connection

If the Ezetrol touch is not integrated in a network, a direct network connection can be established between a PC or laptop computer with Ethernet interface (10/100 MB/sec) and the electronics module using a network cable.

- 1 Using a network cable, connect the electronics module to a PC or laptop computer.
- 2 Assign a fixed IP address and network mask to the PC or laptop (chapter 4.3.3) vergeben.
- 3 Start the browser, e. g. Firefox or Internet Explorer.
- 4 Enter the IP address of the electronics module "http://192.168.200.11" (factory setting) in the address input field. After successful connection, the start screen of the Ezetrol touch appears.

NOTICE

The electronics module and the PC or laptop computer must always have the same network mask and an IP address in the same IP address range. The IP address must not be identical.

4.3.3 Network setting under Windows 10

Windows 10 automatically establishes a network connection as soon as a network card is detected in the PC or laptop computer. All you need to do is assign a fixed IP address and a network mask.

Windows 10 allows you to define two different configurations, e.g. if a laptop is used in different network environments:

- Windows 10 with static (fixed) IP address
- Windows 10 with an alternative configuration if a DHCP server is available

The network connection can be configured on the PC or laptop under "Settings" – "Network and Internet" – "Ethernet" – "Network and Sharing Center" – "Ethernet." All network connections can be checked and adjusted in the lower window.

NOTICE

If the PC or laptop is connected to a network, further elements that must not be deleted or changed may be present! In this case, consult your network administrator!

Windows 10 with static (fixed) IP address

NOTICE

With the setting, a fixed IP address is always assigned to the PC or laptop computer.

- 1 Under "Connections," click "Ethernet". A further menu, "Ethernet status," opens.

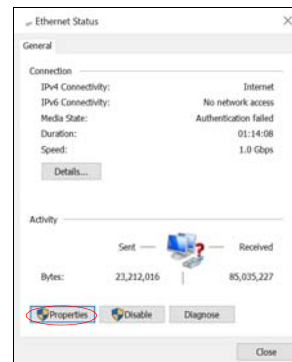

- 2 Click the "Properties" button.

- Under the menu “Ethernet properties,” select the element “Internet protocol Version 4 (TCP/Pv4).” Only the element “Internet protocol Version 4 (TCP/IPv4)” is required; all other elements are not necessary for operation of the electronics module.

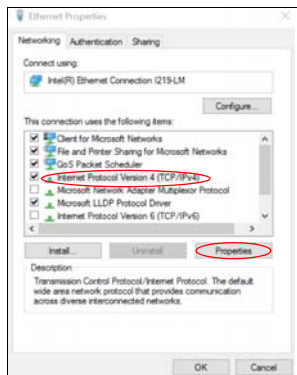

- Click the “Properties” button to configure the element “Internet protocol Version 4 (TCP/Pv4).”
- Activate the selection “Use following IP address.”



- Assign a fixed IP address and network mask. Do not change any other settings.
- Tap the “OK” button twice to confirm and save the entry. In some Windows configurations, it may be necessary to reboot Windows.

Windows 10 with an alternative configuration
With Windows 10, it is also possible to set an alternative configuration.

- Carry out steps 1 to 4 as described under “Windows 10 with static (fixed) IP address”.
- Click the “Alternative configuration” button.
- Activate the selection “User-defined”.

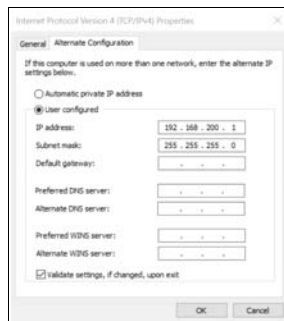

- Assign a fixed IP address and network mask. Do not change any other settings.
- Tap the “OK” button twice to confirm and save the entry. In some Windows configurations, it may be necessary to reboot Windows.

4.4 Modbus TCP interface

The Ethernet interface integrated in the electronics module supports data communication via Modbus TCP protocol. Various data points are available for data exchange (chapter 4.4.1).

Transmission technology: Ethernet in accordance with IEEE802.3

Connection: RJ45 socket, internal

Communication: Supported commands:

- FC03: Read Multiple Registers
- FC16: Write Multiple Registers
- FC06: Write Single Register

The electronics module works as a Modbus TCP slave (server). The data packages are transferred as TCP/IP data packages via the Ethernet interface. Access is via the Modbus register. The port used for the communication protocol Modbus TCP is 502.

4.4.1 Data formats

The table below contains the data format used for transmission of the process data:

Data type	Size (bit)	Typical names	Value range min.	Value range max.
INT8	8	yes	-128	127
UINT8	8	no	0	255
INT16	16	yes	-32.768	32.767
UINT16	16	no	0	65.535
INT32	32	yes	-2.147.483.648	2.147.483.647
UINT32	32	no	0	4.294.967.295
FLOAT	32 (8/23)* ¹	yes	$3.4 * 10^{-38}$ (- $3.4 * 10^{-38}$)	$3.4 * 10^{38}$ (- $3.4 * 10^{38}$)
ASCII	n * 8	no	--	--

*1 Exponent / mantissa

For the byte sequence in which the various data types are saved in the memory or transferred, see the following figures.

Data type INT8 / UINT8

Example using the figure 50 (32 hex):

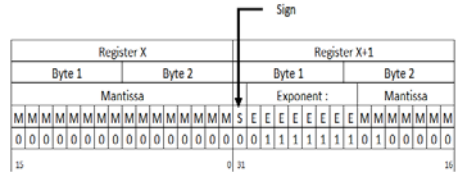
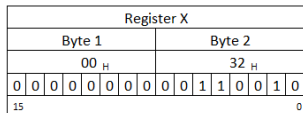

Data type ASCII

The characters are transmitted in accordance with ASCII Codepage 437. Example "mg/l"

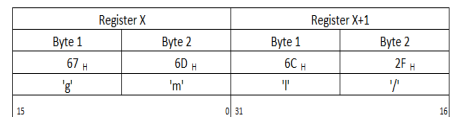

Data type INT16 / UINT16

Using the figure 12589 (312D hex):

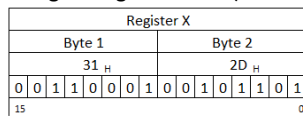

Data type INT32 / UINT32

Using the figure 1212117675 (483F72AB hex):

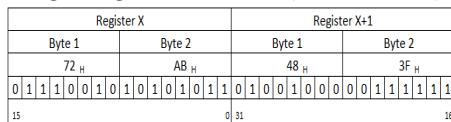

Data type FLOAT

The Float or Real values are transferred in accordance with the IEEE754 Standard Format for 32-bit values. Example using the figure 1.25:

Hexadecimal: 3F A0 00 00 (0: + ; 1: -)

Signed (S): 0

Exponent (E): 0111 1111

Mantissa (M): 010 0000 0000 0000 0000

4.4.2 Reference list

The following reference list contains all available data points and values that can be read and written via Modbus TCP.

NOTICE
It must be noted that write commands should not be set to variables or the Modbus register cyclically or repeatedly set to the same values. Permanent writing of values can cause damage to the device (memory).

Modbus Register Ezetrol touch**IP adress of the device, e.g. 192.168.200.11 Port: 502**

Modbus Register	Bit	Type	No. Byte	Access	Designation	Description
System information						
400001		ASCII	20	R	System name	e.g. "Ezetrol touch"
400011		ASCII	10	R	Software Version	e.g. "V:1.00"
400016		ASCII	10	R	act. date	e.g. "21.02.17"
400021		ASCII	6	R	act. time	e.g. "13:16"
400024		ASCII	16	R	Serial number	
(Ch.1) Chlorine - Measurement						
400100		FLOAT	4	R	Measured value	
400102		ASCII	10	R	Measured unit	"mg/l"
400107		FLOAT	4	R	Lower range	
400109		FLOAT	4	R	Upper range	
400111		FLOAT	4	R	Current setpoint	in the measuring range
400113		FLOAT	4	R	Current measuring range/ control value Yout	0.0 - 100.0%
(Ch.2) pH - Measurement						
400115		FLOAT	4	R	Measured value	
400117		ASCII	10	R	Measured unit	"pH / mg/l"
400122		FLOAT	4	R	Lower range	
400124		FLOAT	4	R	Upper range	
400126		FLOAT	4	R	Current setpoint	in the measuring range
400128		FLOAT	4	R	Current measuring range/ control value Yout	0.0 - 100.0%
(Ch.3) ORP (Redox) - Measurement						
400130		FLOAT	4	R	Measured value	
400132		ASCII	10	R	Measured unit	"mV"
400137		FLOAT	4	R	Lower range	
400139		FLOAT	4	R	Upper range	
400141			4	R	-	
400143			4	R	-	
(Ch.4) Conductivity - Measurement						
400145		FLOAT	4	R	Measured value	
400147		ASCII	10	R	Measured unit	"μS/cm"; "mS/cm"
400152		FLOAT	4	R	Lower range	
400154		FLOAT	4	R	Upper range	
400156		FLOAT	4	R	Current setpoint	in the measuring range
400158		FLOAT	4	R	Current measuring range/ control value Yout	0.0 - 100.0%

Modbus Register	Bit	Type	No. Byte	Access	Designation	Description
(Ch.5) Temperature - Measurement						
400160		FLOAT	4	R	Measured value	
400162		ASCII	10	R	Measured unit	"°C"; "°F"
400167		FLOAT	4	R	Lower range	0,0°C; 32,0°F
400169		FLOAT	4	R	Upper range	50,0°C; 122,0°F
400171			4	R	--	
400173			4	R	--	
Status messages						
400300		UINT16	2	R	Alarm stats	
	0				Alarm 1	1 = Alarm pending
	1				Alarm 2	1 = Alarm pending
	2				Alarm 3	1 = Alarm pending
	3				Alarm 4	1 = Alarm pending
	4				Alarm 5	1 = Alarm pending
	5				Alarm 6	1 = Alarm pending
	6				Alarm 7	1 = Alarm pending
	7				Alarm 8	1 = Alarm pending
400301		UINT16	2	R	Digital inputs	
	0				Sample water STOP - DI1	1 = DI active (open)
	1				DI 2	1 = DI active (open)
	2				DI 3	1 = DI active (open)
	3				DI 4	1 = DI active (open)
	4				DI 5	1 = DI active (open)
400302		UINT16	2	R	Relay outputs	
	0				Relay K1	1 = Relais aktiv
	1				Relay K2	2 = Relais aktiv
	2				Relay K3	3 = Relais aktiv
	3				Relay K4	4 = Relais aktiv
	4				Relay K5	5 = Relais aktiv
	5				Relay K6	6 = Relais aktiv
400303		UINT16	2	R	---	

Modbus Register	Bit	Type	No. Byte	Access	Designation	Description
400304		UINT16	2	R	Operation mode controller 1 (chlorine)	
	0				MAN.	
	1				Auto	
	2				Controller Aus	
	3				Adaption running	
	4				--	
	5				Controller stop (Yout=0%)	
	6				Controller freeze (Yout=Yout)	
	7				Controller Yout=100%	
	8				--	
	9				--	
	10				--	
	11				Eco Mode switching	
12				Controller standby		
400305		UINT16	2	R	Operation mode controller 2 (pH)	Coding see Reg. 400304
400306						
400307		UINT16	2	R	Operation mode controller 4 (Cond.)	Coding see Reg. 400304
400308						
400310		UINT32	4	R	Error code chlorine (Ch.1)	
	0				Zero point calibration	1 = error aktive
	1				DPD calibration	1 = error aktive
	2				pH7 calibration	1 = error aktive
	3				pHX calibration	1 = error aktive
	4				Error calibration e.g. ORP (Redox)	1 = error aktive
	5				Offset calibration	1 = error aktive
	6				--	
	7				Cell error	1 = error aktive
	8				Factory calibration error	1 = error aktive
	9				--	
	10				--	
	11				Setpoint error	1 = error aktive
	12				Limit error	1 = error aktive
	13				HOCL error (Cl2++)	1 = error aktive
	14				--	
	15				Overfeed (max. dosing time)	1 = error aktive
16				Auto tune error	1 = error aktive	

Modbus Register	Bit	Type	No. Byte	Access	Designation	Description
400314		UINT32	4	R	Error code pH/Fluoride (Ch.2)	Coding see Reg. 400310
400318		UINT32	4	R	Error code ORP (Redox) (Ch.3)	Coding see Reg. 400310
400326		UINT32	4	R	Error code temperature (Ch.5)	Coding see Reg. 400310
(Ch.1) Chlorine - Controller parameter						
401000		FLOAT	4	RW	Setpoint (W)	in the measuring range
401002		FLOAT	4	RW	P-element(Xp)	0 - 1000%
401004		FLOAT	4	RW	I-element (Tn)	0.0 - 100.0 min 0 = Tn inactive
(Ch.2) pH - Controller parameter						
401006		FLOAT	4	RW	Setpoint (W)	in the measuring range
401008		FLOAT	4	RW	P-element (Xp)	0 - 1000%
401010			4		--	
(Ch.3) Reserved						
401012						
401014						
401018						
(Ch.4) Conductivity - Controller parameter						
401018		FLOAT	4	RW	Setpoint (W)	in the measuring range
401020		FLOAT	4	RW	P-element(Xp)	0 - 1000%
401022		FLOAT	4	RW	I-element (Tn)	0.0 - 100.0 min 0 = Tn inactive
(Ch.1) Chlorine - Limits						
401050		FLOAT	4	RW	Min. value 1	Lower range - Max 1
401052		FLOAT	4	RW	Max. value 1	Min 1 - Upper range
401054		FLOAT	4	RW	Hysteresis valve 1	1 - 25 Digit
401056		FLOAT	4	RW	Min. value 2	Lower range - Max 2
401058		FLOAT	4	RW	Max. value 2	Min 2 - Upper range
401060		FLOAT	4	RW	Hysteresis value 2	1 - 25 Digit
(Ch.2) pH - Limits						
401062		FLOAT	4	RW	Min. value 1	Lower range - Max 1
401064		FLOAT	4	RW	Max. value 1	Min 1 - Upper range
401066		FLOAT	4	RW	Hysteresis value 1	1 - 25 Digit
401068		FLOAT	4	RW	Min. value 2	Lower range - Max 2
401070		FLOAT	4	RW	Max. value 2	Min 2 - Upper range
401072		FLOAT	4	RW	Hysteresis value 2	1 - 25 Digit

Modbus Register	Bit	Type	No. Byte	Access	Designation	Description
(Ch.3) OPR (Redox) - Limits						
401074		FLOAT	4	RW	Min. value 1	Lower range - Max 1
401076		FLOAT	4	RW	Max. value 1	Min 1 - Upper range
401078		FLOAT	4	RW	Hysteresis value 1	1 - 25 Digit
401080		FLOAT	4	RW	Min. value 2	Lower range - Max 2
401082		FLOAT	4	RW	Max. value 2	Min 2 - Upper range
401084		FLOAT	4	RW	Hysteresis value 2	1 - 25 Digit
(Ch.4) Reserved						
401086		FLOAT	4	RW	Min. value 1	Lower range - Max 1
401088		FLOAT	4	RW	Max. value 1	Min 1 - Upper range
401090		FLOAT	4	RW	Hysteresis value 1	1 - 25 Digit
401092		FLOAT	4	RW	Min. value 2	Lower range - Max 2
401094		FLOAT	4	RW	Max. value 2	Min 2 - Upper range
401096		FLOAT	4	RW	Hysteresis value 2	1 - 25 Digit
(Ch.5) Temperature - Limits						
401098		FLOAT	4	RW	Min. value 1	Lower range - Max 1
401100		FLOAT	4	RW	Max. value 1	Min 1 - Upper range
401102		FLOAT	4	RW	Hysteresis value 1	1 - 25 Digit
401104		FLOAT	4	RW	Min. value 2	Lower range - Max 2
401106		FLOAT	4	RW	Max. value 2	Min 2 - Upper range
401108		FLOAT	4	RW	Hysteresis value 2	1 - 25 Digit

5. Installation

5.1 Scope of delivery

The scope of delivery includes the following, depending on the version selected:

- Electronics module (module name E02) with sensor cable pre-wired
- Flow cell, pressurized version (module name D02)
- LED glow stick (pre-wired)
- Sensors:
 - Chlorine sensor (free chlorine)
 - pH sensor
- Multi-sensor
- Mounting plate
- Top-hat rail
- Assembly accessories
- Instruction manual

5.2 Transport and storage

Transport

The Ezetrol touch Measuring, Control and Dosing System is shipped in standard packaging. During transport, the packaged Ezetrol Touch must be handled carefully and should not be exposed to wet weather or moisture. Check that the transport packaging is undamaged. In the event of damage, please inform the transport company immediately, as your rights to compensation will otherwise be lost. If a component is damaged, please contact your affiliate immediately.

Keep the packaging until the system has been commissioned and put into operation.

Storage

electronics module, flow cell and sensors must be stored in dry condition without any residual water in a dry place that is not exposed to the elements.

Shut-down

The Ezetrol touch may only be taken out of operation by trained and authorized personnel.

5.3 Required ambient conditions

NOTICE

Correct and safe operation can only be guaranteed if the requirements for the ambient conditions are met. All applicable national and local regulations must be observed!

- The Ezetrol Touch must be protected against moisture, rain, frost, heat and direct sunlight and may therefore not be installed outdoors.
- Do not use the Ezetrol touch in environments where there are flammable gases, fumes or dust or conductive dust.
- Do not subject the Ezetrol touch to strong shocks or vibrations.
- The air in the room must be non-condensing.

5.4 Mechanical Installation

WARNING

Risk of injury or damage to the installation!

- Only authorized and qualified electricians are permitted to install the Ezetrol touch.
- All electrical work on the Ezetrol touch must be carried out by authorized and qualified electricians.
- Modifications to the device other than those described in this instruction manual are not permissible.

NOTICE

- Install the flow cell to the left of the electronics module.
- Leave a clearance of at least 250 mm above the flow cell for working with the sensors.
- Screws and dowels for fixing to a solid wall are included in the scope of delivery.
- Tallow-drop screws and dowels for fixing to a solid wall are included in the scope of delivery.
- If the device is to be installed on a suitable lightweight wall, use the appropriate mounting fixtures. Not included in the scope of delivery!

NOTICE

- The electronics module is not suitable for electrical connection with permanently installed cable conduits. If the cable glands do not meet local installation rules and regulations, these glands must be replaced with suitable ones.
- If the electronics module and flow cell are mounted in separate locations, the use of optional sensor extension cables is required. A length of 164 feet (50 m) must not be exceeded. For the pH or fluoride sensor, an optional impedance converter is required when longer cables are utilized.
- In cases where the sensor cable is not long enough and an extension is required, an impedance converter must be screwed onto the pH and fluoride sensor. The impedance converter converts the very high-resistance sensor signal into a low-resistance signal. The impedance converter is supplied by a built-in battery with a battery service life of approximately 5 years. After this time, the impedance converter should be sent to our company to have the battery replaced.
- Dimension drawing chapter 5.5.3: Measurement are shown in millimeters. To convert to inch measurement, divide by 25.4 (1 inch = 25.4 mm).

- 1 Installation of the module (chapter 5.5)
- 2 Remove the housing cover of the flow cell (chapter 5.6).
- 3 Install the optional strainer (chapter 5.7).
- 4 Connect the sample water inlet (chapter 5.8)
 - with tubing connection
 - with rigid pipework
- 5 Connect the sample water outlet (chapter 5.9).
- 6 Insert electrode cleaning sand (chapter 5.10.1).
- 7 Install sensors, LED glow stick and Multi-sensor (chapter 5.11).
- 8 Fit calibration aids (chapter 5.11.1).
- 9 Refit the housing cover (chapter 5.6).

5.5 Installation of the module

Install the electronics module and flow cell with or without DIN rail. Dimension drawing chapter 5.5.3.

5.5.1 With DIN rail

- 1 Secure the DIN rail to a solid wall using the dowels and screws supplied.
- 2 Hook the electronics module onto the DIN rail so that it is flush at the right.
- 3 Fasten the electronics module to the solid wall at the bottom by the holders using dowels and screws.
- 4 Hook the flow cell on the DIN rail to the left of the electronics module.
- 5 Fasten the flow cell to the solid wall at the bottom by the holders using dowels and screws.

5.5.2 Without DIN rail

The dimensions for the drilling pattern can be found on the back of the plastic housing.

- 1 Attach the tallow-drop screws and dowels provided to the solid wall (included in the scope of delivery).
- 2 Hook the electronics module onto the screws.
- 3 Fasten the electronics module to the solid wall at the bottom by the holders using dowels and screws.
- 4 Hook the flow cell onto the screws.
- 5 Fasten the flow cell to the solid wall at the bottom by the holders using dowels and screws.

5.5.3 Dimension drawing

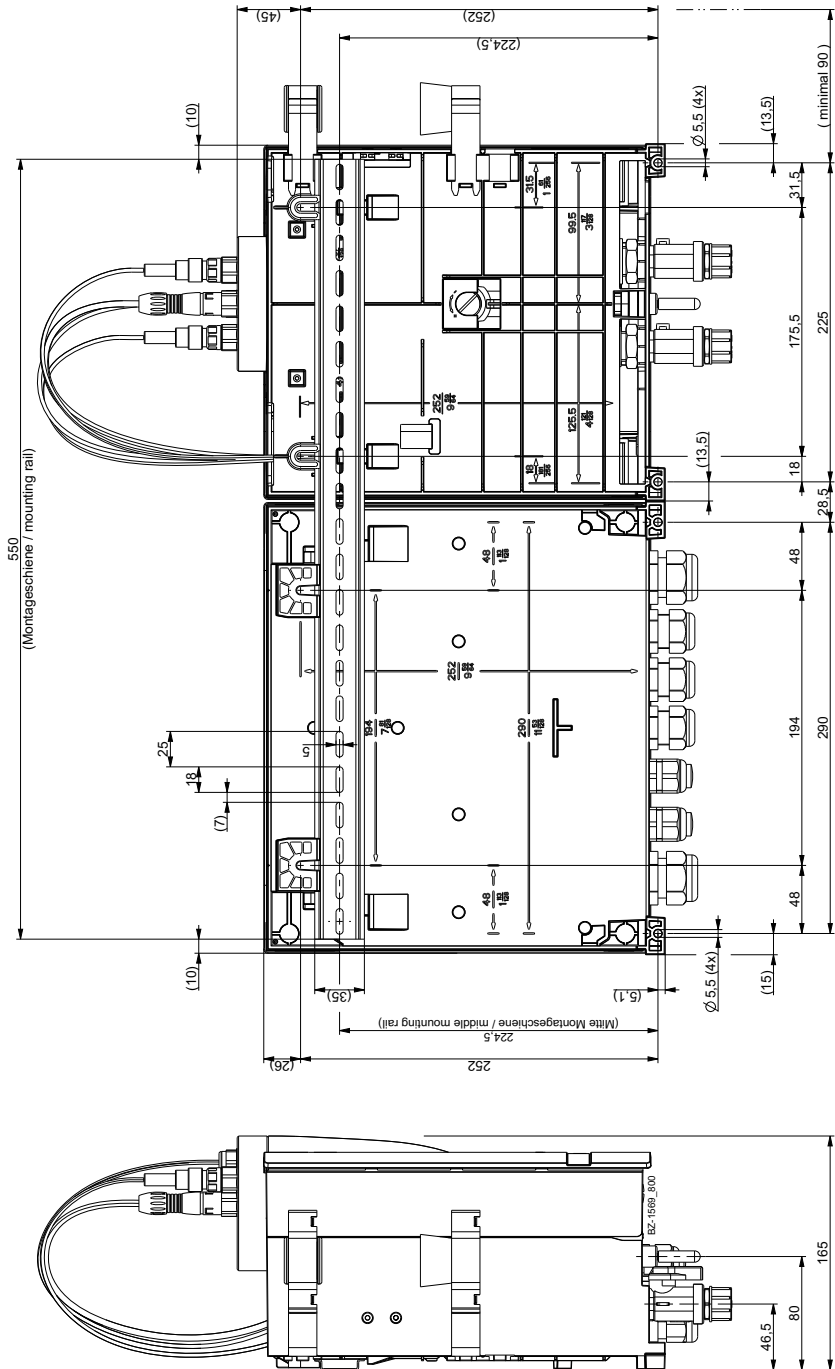

5.6 Removing and fitting the housing cover

5.6.1 Flow cell

Removing

- Remove the housing cover of the flow cell. To do this, press both unlocking buttons (A) on the top of the housing and carefully remove the cover toward the front.

Fitting

- Fit and engage the housing cover of the flow cell. To do this, position the housing cover at the bottom and carefully press it upward until the housing cover engages on the unlocking buttons..

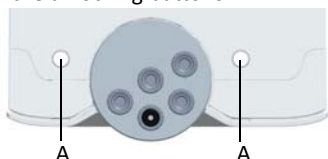

Fig. 1 View of top of housing cover

A *Unlocking buttons*

5.6.2 Electronics module

Removing

- 1 Release the four screws on the housing cover.
- 2 Remove the housing cover carefully.
- 3 Hook the housing cover into the holders (A) on the basic housing.

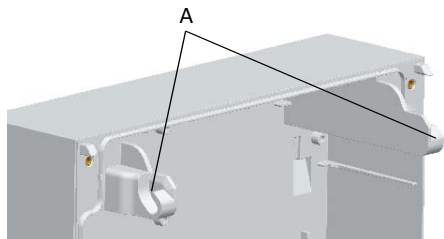

Fig. 2 Section, housing cover

A *Holders*

Fitting

- 1 Place the housing cover carefully on the basic housing.
- 2 Tighten the housing screws by hand (to a maximum torque of 0.5 ft-lb \pm 0.11 ft-lb (0.7 Nm \pm 0.15 Nm)).

5.7 Installing the optional strainer

- 1 Release the screw joint on the sample water inlet with ball valve (A) (threaded connection G 1/2" A).
- 2 Connect strainer with pipe clamp (B).
- 3 Connect sample water inlet (C).

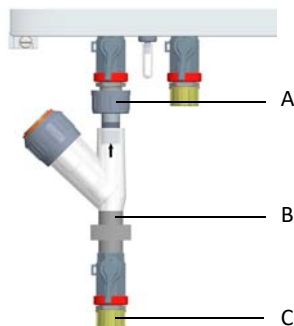

Fig. 3 Section, installation of strainer

- A Screw joint on sample water inlet with ball valve
 B Strainer with pipe clamp
 C *Sample water inlet*

5.8 Connecting the sample water inlet

NOTICE

No water pipes made of copper may be fitted in the installation. They would falsify the measurement.

- The sample water inlet must be installed upstream of the flocculant dosing station. Otherwise, it could influence the measurements.
- The sample water inlet must be installed according to the local regulations in the pool return line.
- The sample water inlet must be chosen to ensure that the water sample is representative with a constant, bubble-free flow and a constant pH value (range from 6 to 8).
- A distinction must be made between a sample water inlet with tubing connection and a sample water inlet with rigid pipework.
- PVC hose \varnothing 6x3 or PVC pipe DN 6.

- To prevent long loop dead times, ensure that the lines in the sample water inlet are as short as possible and do not have a large line cross-section. Long measuring dead times mean poorer control quality!
- The pressure in the sample water inlet must always be within a range of min. 4 to max. 45 psig (min. 0.25 to max. 3.0 bar). The pressure in the sample water inlet must always be 4 psig (0.25 bar) higher than in the sample water outlet.
- If the inlet pressure is below 4 psig (0.25 bar), a booster pump must be used (chapter 5.10).
- If the inlet pressure exceeds 45 psig (3.0 bar), an optional pressure reducing valve must be used (chapter 5.10).
- To protect the flow cell against contamination, an optional strainer with a mesh width of 0.02" (0.5 mm) should be provided on the sample water inlet (chapter 5.7).

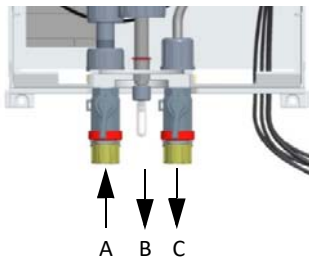

Fig. 4 Section, flow cell

- A *Sample water inlet with ball valve*
 B *Flow cell drain valve (drain at the drain screw)*
 C *Sample water outlet with ball valve*

5.8.1 With tubing connection

NOTICE

The water-tightness of the hose screw connection is only guaranteed if the following installation instructions are followed!

- 1 Release union nut (C) on the hose screw connection.
- 2 Insert the tubing (D) until it meets the hose bushing (A).
- 3 Push the locking ring (B) out until the union nut (C) engages the connecting threads.

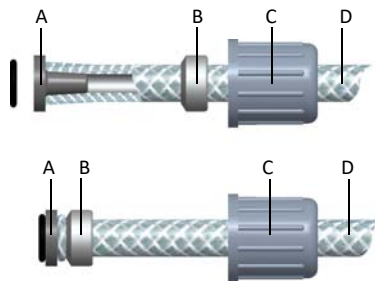

Fig. 5 Detail of hose screw connection

- A *Hose bushing*
 B *Locking ring*
 C *Union nut*
 D *Tuning*

5.8.2 With rigid pipes

NOTICE

Ensure that the sample water pipes are installed free of mechanical stress.

- 1 Connect the sample water pipework to the connection thread (G1/2" A) of the ball valve.

5.9 Connecting the sample water outlet

NOTICE

No water pipes made of copper may be fitted in the installation. They would falsify the measurement.

- 1 On the pressurized version, a maximum back-pressure of 22 psig (1.5 bar) is permitted on the sample water outlet.
- 2 Ensure that the drain screw (flow cell drain valve) is always closed, see chapter 3.6.1.

5.10 Sample water extraction options

Example for sample water extraction using a booster pump

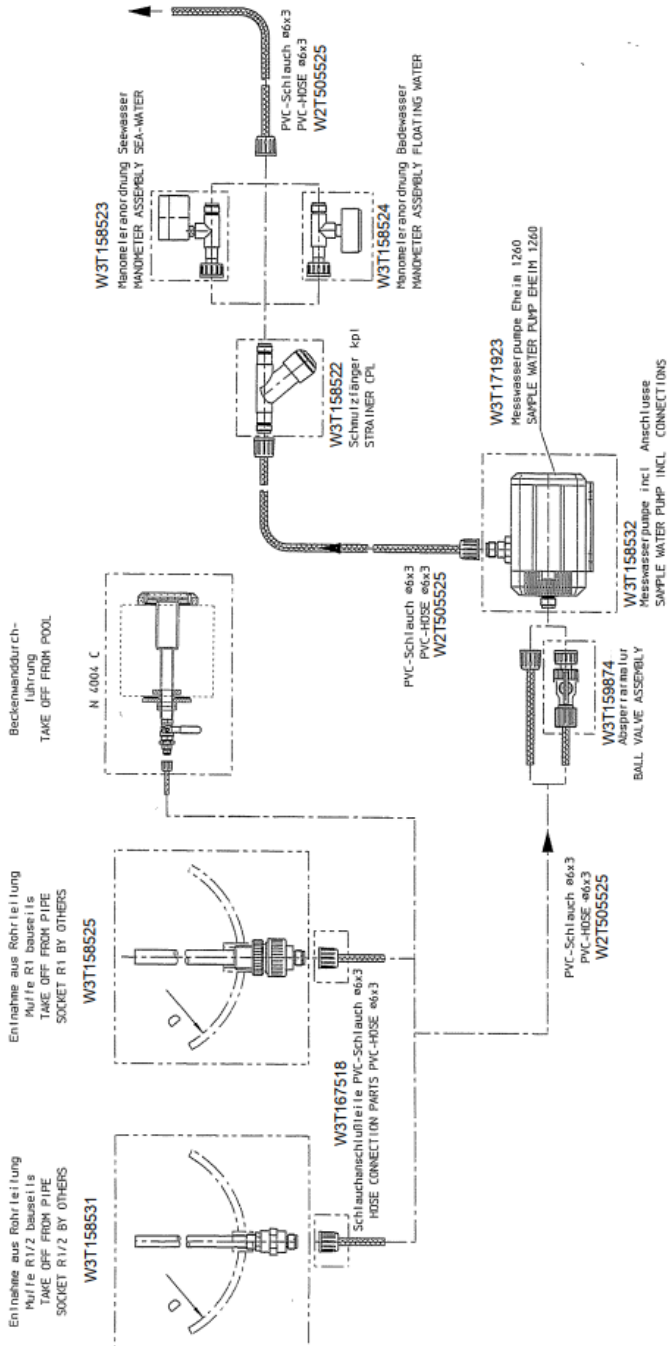

Only operate with sample water inlet!

Example for sample water extraction - Part list on page 42

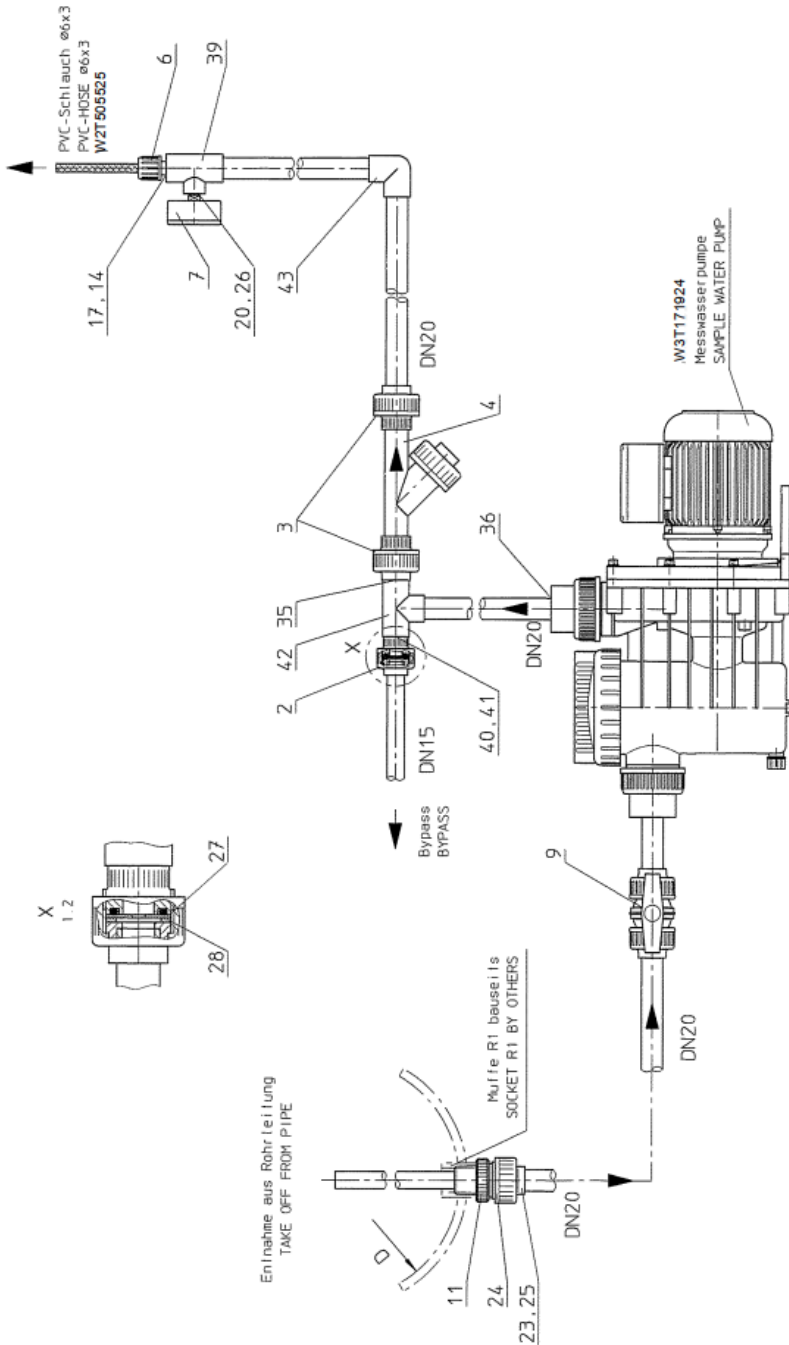

Only operate with sample water inlet!

Beispiel:

Sample water extraction, drawing on page 41

- for fresh water (Part no. W3T158528)
- for salt water (Part no. W3T158529)

Item	Qty.	Part No.	Designation
2	1	W2T505181	Screw joint
3	2	W2T505182	Screw joint
4	1	W3T171416	Strainer complete
6	1	W3T167518	Hose connection parts
7	1	W3T173160 W3T173198	Pressure gage: • fresh water • salt water
9	1	W2T505945	Ball valve
11	1	W3T163670	Sample pipe
14	1	W3T172948	Threaded part
17	1	W2T505600	Reduction
20	1	W3T163500	Reduction nipple
23	1	W2T507288	Insert
24	1	W2T506934	Union nut
25	1	W3T172720	O-ring
26	1	W3T161254	Flat gasket
27	1	W3T171146	Nozzle washer
28	1	W3T172727	Flat gasket
35	1	W3T166090	Pipe segment
36	2	W2T506782	Reducing junction, short
39	1	W2T506527	T-piece
40	1	W3T166089	Pipe segment
41	1	W2T506778	Reducing junction, short
42	1	W2T507525	T-piece
43	1	W2T507535	Elbow bend

5.10.1 Inserting or replacing electrode cleaning sand

The electrode cleaning sand (part no. W3T171317) is supplied in a plastic bottle, the cap serves as a measure. See design flow cell chapter 3.6.1.

- 1 Close the ball valve on the sample water inlet and outlet.
- 2 Open the drain screw on the sample extraction unit and empty the cell body. To do so, temporarily loosen a plug or sensor to allow air to flow in.
- 3 When the cell body is empty, close the drain screw once more.
- 4 Remove the housing cover of the flow cell.
- 5 Unscrew the flow distributor cap. Hold a container under-neath, as the remaining water will drip out.
- 6 **Replace the electrode cleaning sand:** Flush out the electrode cleaning sand of the flow distributor cap.
- 7 Fill the cap of the cleaning sand bottle until it is one-third full.
- 8 Then pour the electrode cleaning sand into the middle of the flow distributor cap (Fig. 6). The inner indentation of the flow distributor cap is filled roughly half-way with electrode cleaning sand.



Fig. 6 Flow distributor cap

- 9 Screw the flow distributor cap back on.
- 10 Open the ball valve on the sample water inlet and outlet. The cell body fills with sample water again.
- 11 Replace and engage the housing cover of the flow cell.
- 12 After 2 to 3 hours running-in time, perform a chlorine calibration. If necessary, repeat the chlorine calibration after 24 hours. (chapter 6.6).

NOTICE

An initial rotating air bubble at the bottom of the cell body does not affect the measurement.

5.11 Installing and connecting sensors, LED glow stick and multi-sensor

NOTICE

The sensors must be prepared accordingly. Keep the watering cap of the chlorine sensor and the transport container of the pH and ORP sensors in a safe place for later use. Please follow the relevant operating instructions for the sensors!

- 1 Remove the plug from the mount hole on the cover of the cell body.
- 2 Remove the watering cap from the chlorine sensor.
- 3 Screw the sensor into the mount hole (A) in the cell body cover.
- 4 Remove the pH or ORP sensors from the KCl tank with stand.
- 5 Screw them into the mount holes (C or E) in the cell body cover.
- 6 Install the conductivity sensor (optional) into the mount hole (B) and fix with clamp connection.
- 7 Connect the sensors to the electronics module with the pre-fitted cables. To do this, feed the cables through the lower hole (F) into the housing of the flow cell and connect to the sensors as described below:
 - Feed the LED glow stick through the opening (F) and out of the housing and screw it into the mount hole (D) in the cell body cover.
 - Feed the multi-sensor (G) through toward the left behind the cell body and plug it into the flow control valve (remove blind plug first).
 - Route sensor cables upward and out of the housing through opening (F), and connect the "free chlorine" sensor cable with the chlorine sensor
 - The pH and ORP sensor cable connectors with the pH and ORP sensors.

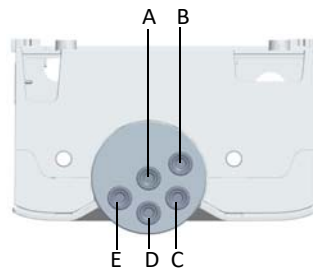

Fig. 7 View of top of housing cover

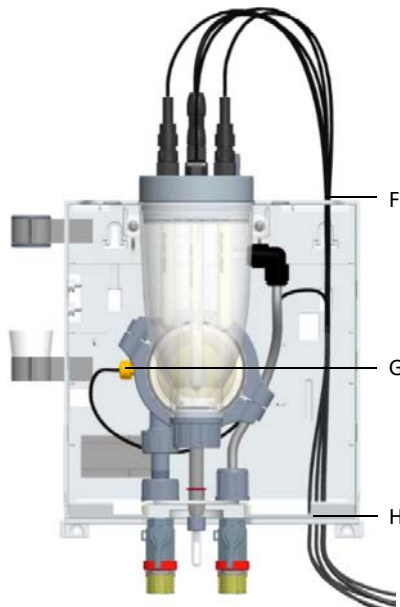

Fig. 8 Cross-section, flow cell

- A Chlorine sensor (free chlorine)
- B Conductivity sensor
- C ORP (Redox) sensor
- D LED glow stick
- E pH sensor
- F Housing opening for sensor cables (upper bore hole)
- G Multi-sensor
- H Housing opening for sensor cables (lower bore hole)

5.11.1 Installing calibration aids

Two calibration clips are installed in the housing of the basic housing at the back. The clip with the plastic insert for the sensor is pushed into the top catch (A). The second clip is for holding calibration solution or buffer solution in a bag or beaker. For solution in a bag, fit the clip in the top position of the bottom catch (B). For solution in a beaker, select the position below (C).

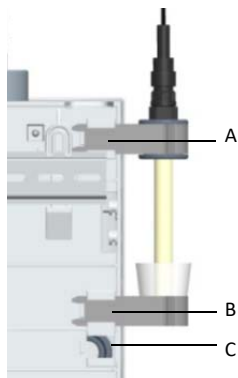

Fig. 9 Rear side of flow cel

- A Top holding clip for sensor mounting
- B Position of holding clip for bag
- C Position of holding clip for beaker

5.12 Electrical installation

⚠ DANGER

Risk of injury or death!

External voltages may still be connected even if the operating voltage is switched off. Disconnect all power sources before opening the electronics module.

⚠ WARNING

Risk of injury or damage to the device!

- Only authorized and qualified electricians are permitted to install the Ezetrol touch and open the housing.
- The electronics module may only be put into operation when the housing is closed, and must be connected to protective earth.
- Modifications to the device other than those described in this instruction manual are not permissible.
- The electronics module may only be wired in de-energized state.
- Connect the electronics module in accordance with the wiring diagram (chapter 9.) and applicable local and national regulations.
- High temperatures at the terminals of the relays and the mains supply!
At high ambient temperatures, high temperatures can occur at the terminals, and the connected cables must be designed to withstand such temperatures.
Ambient temperature <30°C (<86°F):
cable temperature resistant up to at least 60°C
Ambient temperature <40°C (<104°F):
cable temperature resistant up to at least 70°C
Ambient temperature >40°C (>104°F):
cable temperature resistant up to at least 80°C

NOTICE

- The electronics module is not suitable for electrical connection with permanently installed cable conduits.
- If the cable glands do not meet local installation rules and regulations, these glands must be replaced with suitable ones.
- The electronics module is equipped with a flexible voltage supply input and accepts AC voltages from 100 to 240 volts. Take the power consumption into account when dimensioning (chapter 3.8).

**WARNING****Risk of injury or damage to the device!**

- The Ezetrol touch is not equipped with a mains switch and is in operation as soon as the supply voltage is applied. For this reason, an external switch or circuit breaker with a clearly identifiable "Off" switch position is necessary.
- Line cross-section for the mains input side at least 0.75 mm² (AWG 18), on-site mains fuse 6 A with 100 to 240 V AC supply.
- When connecting system components (e.g. devices, motors, pumps) as well as when entering operating data, the system components must be switched off in order to prevent uncontrolled activation or incorrect operation.
- If devices are connected to the internal voltage supply (e.g. dosing devices) or via fixed connection cables (e.g. connectors), the total power consumption must not exceed 6 A.

- 1 Open the housing cover of the electronics module.
- 2 Connect the power supply in accordance with the wiring diagram (chapter 9.).

NOTICE

Note the correct polarity of the voltage connections and the correct dimensioning of the wire cross-sections (chapter "3.8 - Power consumption).

- 3 Installing a retrofit kit (optional) for mA outputs or Redox or conductivity (chapter 5.14).
- 4 Wire the CPU-board in accordance with wiring diagram chapter 9.

NOTICE

Make sure that all cable glands are installed correctly.

- 5 Fit the housing cover.
- 6 Then put the Ezetrol touch into operation (chapter 5.13).

5.13 Startup

DANGER

Risk of injury or death!

The Ezetrol touch must not be operated with flammable liquids.

ATTENTION

Risk of injury or damage to the device!

- To ensure safe and correct commissioning, knowledge of the operation, connected electrical load, measurement signals, cable assignment and fuse protection of the connected devices and machines and the relevant safety regulations is required.
- Startup of the Ezetrol touch may therefore only be performed by qualified and authorized electricians.
- Incorrectly connected devices can be damaged, possibly irreparably, or cause faults in other equipment when they are switched on or in operation.
- Ensure that the measuring and control cables are not confused or make contact with one another.
- Never connect or disconnect any cables to which voltage is applied.

WARNING

Risk of injury or damage to the device!

When connecting the Ezetrol touch to the power supply, a 6A back-up fuse must be used in the mains supply line.

Following complete mechanical and electrical installation, initial commissioning can be carried out. Please check that the following conditions are met:

- Electronics module and flow cell are installed.
- Electrode cleaning sand is filled.
- Housing covers are fitted.
- Optional strainer is installed.
- Sample water inlet and outlet are connected.
- Sensors are installed in the flow cell.
- The sensors are connected to the electronics module.

- The electronics module is wired in accordance with the wiring diagram (circuit diagram) and local regulations.
- Ensure that all transport protection was removed.
- Check all connections for leakage.
- Sample water monitoring and circulation monitoring are active (chapter 3.5.7).

1 Switch on power supply.

2 Perform initial configuration:

- Set "MANUAL" mode
- Select the language
- Set the date and time
- Enter the system name

3 **Chlorine measurement**

- Set the dosing output for Cl₂, if necessary set positioner running time "Ty," "Tp" or "Max. pulses/min."
- Check setpoint for Cl₂ control, change if necessary (only for Cl₂ closed-loop control).
- Adapt values for "Xp" and "Tn" to control loop.

NOTICE

These values may be optimized later by Auto tune or manually.

- Check the limit values 1 and 2 for Cl₂ ("Min" and "Max"), adjust if necessary.
- Check the measurement range for Cl₂, adjust if necessary.

4 **pH measurement**

- Set the dosing output for pH, if necessary set positioner running time "Ty," "Xsh," "Tp" or "Max. pulses/min."
- Set the control direction (for pumps 2P).
- Check the setpoint for pH control, adjust if necessary.
- Adapt the values for "Xp" and "Tn" to the control loop, if necessary optimize in small steps.
- Check the limit values 1 and 2 for pH ("Min" and "Max"), adjust if necessary.

- 5 **ORP (Redox) measurement (if available)**
 - Check the limit values 1 and 2 for ORP ("Min" and "Max"), adjust if necessary.
 - Check the measurement range for ORP, adjust if necessary.
- 6 **Conductivity measurement (if available)**
 - Check the limit values 1 and 2 for conductivity ("Min" and "Max"), adjust if necessary.
 - Check the measurement range for conductivity, adjust if necessary.
 - Activate controller for conductivity, if necessary.
 - Set control outputs for conductivity, if necessary.
 - Set the setpoint for conductivity, if necessary.
- 7 Adapt the values for "Xp" and "Tn" to the control loop, if necessary.
- 8 Configure alarms as required.
- 9 Configure analog outputs as required.
- 10 Define function DI2 and DI3.
- 11 Parametrize interfaces.
- 12 In Manual mode, check all connected dosing devices for correct functioning.
- 13 Test Cl₂ feed lockout activated functions such as circulation monitoring and Sample water Stop.
- 14 Carry out initial calibration of the sensors after a running time of approx. one hour.
- 15 Switch to Automatic mode and monitor system for correct functioning.
- 16 Repeat calibration after a running-in time of approx. 24 hours.

5.14 Installing retrofit kits/extensions

DANGER

Risk of injury or death!

External voltages may still be connected even if the operating voltage is switched off.

5.14.1 4-way mA output card

- 1 Disconnect the electronics module from the power supply.
- 2 Remove the housing cover of the electronics module.
- 3 Install mA output card at position A and make sure that the holders engage. Note the correct installation direction.
- 4 Plug in terminal block at position B.
- 5 Wire in accordance with the wiring diagram (chapter 9.).
- 6 Fit the housing cover.
- 7 Connect the power supply again.
- 8 The electronics module automatically detects the installed modules and enables the corresponding settings menus.
- 9 Configure mA outputs as required.
- 10 Check all menu settings and configure if necessary.

NOTICE

After changes the electronics module resets all parameter to factory settings.



Fig. 10 View, installation of the 4-way mA output card

5.14.2 ORP sensor measuring module

- 1 Disconnect the electronics module from the power supply.
- 2 Remove the housing cover of the electronics module.
- 3 Feed the ORP (Redox) sensor cable through the cable gland together with the pH sensor cable with double sealing insert.
- 4 Connect sensor cable to the ORP (Redox) sensor card (A).
- 5 Insert sensor card into Mod1 slot (B). Ensure that the holders engage. Rout the sensor cable upward and around the sensor module to the cable gland.
- 6 Remove the cover of the flow cell.
- 7 Install ORP (Redox) sensor in the flow cell. Please remove the blind plug first (note position!).
- 8 Feed the sensor cable through the hole at the bottom into the housing of the flow cell and route upward to the sensor.
- 9 Connect sensor cable to the ORP (Redox) sensor.
- 10 Fit the housing cover.
- 11 Switch the device on.

NOTICE

The sensor card is automatically detected and the ORP measurement is displayed.

- 12 Calibrate the ORP sensor.
- 13 Set the limit values and perform ORP settings.

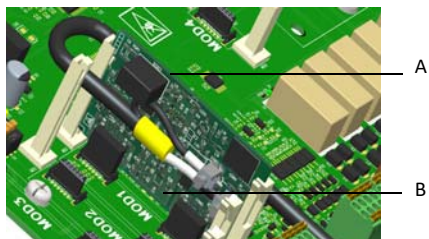

Fig. 11 Section ORP sensor module with sensor cable in slot

- A ORP (Redox) sensor card
B Mod1 slot

5.14.3 Conductivity sensor measuring module

- 1 Disconnect the electronics module from the power supply.
- 2 Remove the housing cover of the electronics module.
- 3 Feed the conductivity sensor cable through the cable gland together with the glow stick cable in double sealing insert.
- 4 Plug the terminal block (B) into the motherboard input Module 2.
- 5 Connect sensor cables in accordance with the wiring diagram (chapter 9.).
- 6 Insert sensor card (A) into Mod2 slot. Ensure that the holders engage.
- 7 Remove the cover of the flow cell.
- 8 Install conductivity sensor in the flow cell. Please remove the blind plug first (note position!).
- 9 Feed the sensor cable through the hole at the bottom into the housing of the flow cell and route upward to the sensor.
- 10 Connect sensor cable to the conductivity sensor.
- 11 Fit the housing cover.
- 12 Switch the device on.

NOTICE

The sensor card is automatically detected and the conductivity measurement is displayed.

- 13 Calibrate the conductivity measurement.
- 14 Set the limit values and perform conductivity and control settings.

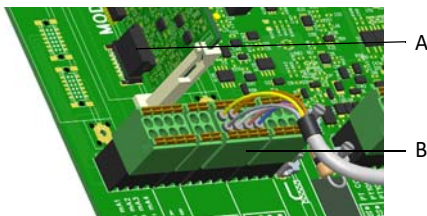

Fig. 12 Detail of conductivity sensor measuring module

- A Sensor card
B Terminal block

5.15 Shut-down



DANGER

Risk of injury or death!

External voltages may still be connected even if the operating voltage is switched off.

- 1 Disconnect the electronics module from the power supply.
- 2 Drain the sample water supply line and drainage line.
- 3 Remove the housing cover of the flow cell.
- 4 Drain the cell body via the sample extraction unit.
- 5 Flush out the cleaning sand.
- 6 Dismantle the filter unit and the check valve housing (chapter 7.5).
- 7 When the remaining water has drained from the flow control valve, refit the filter housing and the check valve housing.
- 8 Remove the sensors from the mount hole in the cover of the cell body and disconnect from the electronics module.
- 9 Shut down the sensors. See relevant operating instructions for the sensors.
 - Fit watering cap (filled with diluted potassium chloride solution) to the chlorine sensor.
 - Plug in the pH or ORP sensor in the KCl tank and stand with KCl solution.
 - Cleaning the conductivity sensor or wash the sensor in distilled water. Store the conductivity sensor in a dry place.
 - Store the sensors in a frost-free place.
- 10 Replace and engage the housing cover.

5.16 Renewed start up

See chapter 5.13.

6. Operation

6.1 Display and control elements

The colored graphic display with capacitive touchscreen is the display and control element.

⚠ ATTENTION

Damage to the touchscreen!
Touching the touchscreen with pointed or sharp objects or striking the touchscreen with hard objects will damage the glass surface. Only touch the touchscreen with your finger or with a pen designed for that purpose (PDA pen).



Fig. 1 Home screen (example)

- A System menu
- B Device name
- C Menu field Measurement with current measured value for chlorine, setpoint display and bar graph
- D Menu field Measurement with current measured value for pH, setpoint display and bar graph
- E Limit value is exceeded
- F Error message
- G Logout/Login-Level
- H Data logger symbol USB memory stick
- I Current time
- J Current temperature
- K Menu field Measurement with current measured value for ORP (Redox), setpoint display and bar graph
- L Display range for alarm
- M Display range for digital input
- N Operation mode

Main scrture

















From the main menu, you can call up the system settings, the measured values menus and the controller menus. To access the corresponding menus, tap the Measurement menu fields or tap the  "System menu" symbol.

Menu field

The menu fields are used to carry out functions and to switch between the menu fields, menus and screens. The Home screen view depends on the sensors that are fitted.

Symbols

The symbols display function. There are also symbols with underlying functions. This means that functions can be carried out or changed by tapping certain symbols.

Symbols	Meaning
	Numeric keypad
	Enter key - save entry
	Upper-case character keypad
	Delete previous keypad entry
	Limit value Min. 1/2 not reached
	Limit value Max. 1/2 exceeded
	Menu Information
	Temperature display
	Setpoint controller
	Dosing on (raise/positioner open)
	Dosing on (reduce/positioner closed)
	Increase value
	Reduce value
	Switch to Home menu
	Switch to the previous screen
	Logout and Login levels screen Level 1 = white symbol Level 2 = yellow symbol Level 3 = blue symbol

Symbols	Meaning
	Message/error active Tap the symbol to open the message window. <ul style="list-style-type: none"> Yellow symbol = alarm that cannot be acknowledged is active Red symbol = alarm that can be acknowledged is active or error message is active
	Data logger symbol USB memory stick
	Menu Alarms
	Digital input active
	Sample water Stop
	Alarm active (1 to 8)
	Calibration menu
	Settings menu
	Acknowledge button
	Selection disabled
	Selection enabled
	Controller Stop
	Controller manual mode
	Controller constant
	Controller automatic mode
	System menu
	Menu/Measurements display
	Confirmation prompt
	Information
	Note
	Abort/Close
	Acknowledge button

6.2 “Measurement” menu field

This menu shows the current measured value and the sensor signal. All settings relating to measurements, such as range, limit values, controller settings and calibration must be made via this menu.

- 1 Call up the Home menu.
- 2 Tap the desired measurement (e.g. Chlorine).

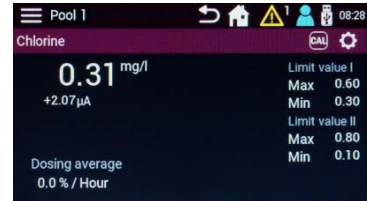

- 3 Tap the symbol.

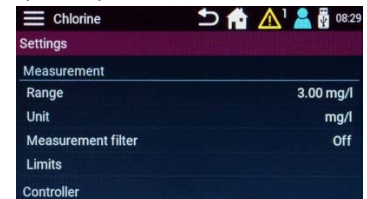

Depending on the measurement selected, different setting parameters are displayed. Swipe upward on the touchscreen to access further setting parameters which are further down the list and not currently visible on the screen.

The settings menus are subdivided into various areas such as Measurement, Controller and Dosing. To change values, press the corresponding parameter.

NOTICE

Depending on the user administration configuration and the currently registered users, the changes that can be made are limited. In order to change parameters, login on the corresponding user level is required (chapter 6.3.8).

Chlorine measurement parameters

Measurement
Range: 1, 2, 3, 5 and 10 mg/l
Unit: mg/l, ppm
Measurement filter: off/low/middle/strong
Limits
Limits value I
Max: within range
Min: within range
Hysteresis: 0.01 to 0.25
Limits value II
Max: within range
Min: within range
Hysteresis: 0.01 to 0.25
Controller
Setpoint: within range
Proportional factor Xp: 1 bis 1000
Integral action time Tn: 0 bis 100.0 min
Auto tune: Starten
Dead time Tu: 1 bis 480 min
Rise time Ts: 1 to 60 min
Dosing
Actuator: Dosing pump 2P, solenoid pump, positioner wo. Ym, analog output mA, dosing contact
Cycle period Tp: 10 to 180 s
max. pulse: 100/120/140/160/180
Running time Ty: 10 to 180 s
Hysteresis: 0.01 to 0.50
min. duty cycle: 00:00 to 10:00 h
max. off-duty cycle: 00:00 to 10:00 h
Reset dosing average
Sampling time Ta

pH measurement parameters

Measurement
Upper range: pH 8 to 14
Lower range: pH 0 to 6
Measurement filter: off/low/middle/strong
Limits
Limits value I
Max: within range

Min: within range
Hysteresis: 0.01 to 0.25
Limits value II
Max: within range
Min: within range
Hysteresis: 0.01 to 0.25
Controller
Setpoint : within range
Proportional factor Xp
Integral action time Tn
Dosing
Actuator: Dosing pump 2P, dosing pump 3P, solenoid pump 2P, solenoid pump 3P, positioner wo. Ym, analog output 2P, analog output 3P, dosing contact
Direction: Acid/Alkali
Cycle period Tp: 10 to 180 s
max. pulse: 100/120/140/160/180
Running time Ty: 10 to 180 s
Hysteresis: 0.01 to 0.50
min. duty cycle: 00:00 to 10:00 h
max. off-duty cycle: 00:00 to 10:00 h
Reset dosing average
Sampling time Ta

ORP (Redox) measurement parameters

Measurement
Upper range: 600/700/800/900/1000
Lower range: 0/100/200/300/400
Measurement filter: off/low/middle/strong
Limits
Limits value
Max: within range
Min: within range
Hysteresis: 1 to 25
Limits value II
Max: within range
Min: within range
Hysteresis: 1 to 25

Conductivity measurement parameters

Measurement
Upper range : 5.00/10.0/20.0/50.0/100.0/200.0/300.0 mS/cm 500/1000/2500 µS/cm
Unit : mS/cm, µS/cm
Measurement filter : off/low/middle/strong
Additional display : off/NaCl [g/l]/TDS
TDS Factor : 0.40 to 1.00
Reference temperature : 20°C/25°C
Limits
Limits value
Max : within range
Min : within range
Hysteresis : 0.01 to 0.25
Limits value II
Max : within range
Min : within range
Hysteresis : 0.01 to 0.25
Controller
Setpoint : within range
Proportional factor Xp : 1 to 1000
Integral action time Tn : 0.0 to 100.0 min
Dosing
Actuator : Dosing pump 2P, solenoid pump 2P, analog output 2P, dosing contact
Cycle period : 10 to 180 s
max. pulse : 100/120/140/160/180
Hysteresis : 0.01 to 0.50
min. duty cycle : 00:00 to 10:00 h
max. off-duty cycle : 00:00 to 10:00 h
Reset dosing average

Temperature measurement parameters

Measurement
Measurement filter
Limits
Limits value I
Max : 0 to 50 °C
Min : 0 to 50 °C
Hysteresis : 0.1 to 2.5 °C
Limits value II
Max : 0 to 50 °C
Min : 0 to 50 °C
Hysteresis : 0.1 to 2.5 °C









6.3 “System” menu

Access to the operating and configuration level of the electronics module is possible via the System menu. All setting parameters not relating to measured values, for example, Alarms, I/O inputs and outputs, interface parameters etc., are parametrized via the System menu.

- 1 Call up the Home menu.
- 2 Press the  symbol.







- 3 Press the desired menu.

Symbol/Menu	Meaning
 Home menu	Home screen
 Operation mode	“Operation mode“ menu
 Calibration	“Calibration“ menu
 Inputs/Outputs	Configuration of inputs and outputs
 Alarm configuration	Configuration alarms
 Login	Login screen for entry of the password or unlock code
 Settings	Settings menu
 Information	Info display

6.3.1 “Operation mode” menu

Select in this menu the operation mode.

- 1 Call up the Home menu.
- 2 Tap  or  symbol or tap the  symbol and then  Operation mode menu.



- 3 To switch to “Manual mode,” press the “Change” button. An additional prompt appears, i.e. in order to change the operation mode, you need to confirm the prompt with “Yes” or “No.”
- 4 In “Manual mode,” it is possible to switch the dosing contact on and off manually via the “ON/OFF” button.

Manual dosing rate chlorine

Chlorine: 0 to 100 %/on/off

pH: -100 to +100 %/on/off

Conductivity: 0 to 100 %

Furthermore, a runtime limitation can be set for manual dosing (not with positioner). Dosing is switched off after expiry of this time. If the running time is set to 00:00, it is inactive and manual dosing is in continuous mode.

Running time

Chlor, pH, conductivity: 00:00 to 23:59 h

- 5 In “Automatic mode” it is possible to switch to the settings level by pressing the  symbol.

6.3.2 “Calibration” menu

In this menu, the measurements are compared in compliance with the prescribed maintenance intervals using calibration solution or buffer solution or via comparative measurements (chapter 6.6). The date of the last calibration and the calibration value entered are displayed. Depending on the desired measurement, the corresponding calibration menus can be selected. The menu can be opened in via the  System menu or via the Measurement menu field.

Calibration - System menu

- 1 Call up the Home menu.
- 2 Tap the  symbol.



- 3 Press  Calibration menu.
- 4 Tap the desired measurement (e.g. Chlorine).



- 5 Press calibration selection, see “Calibration selection” on page 55.
- 6 Carry out sensor calibration as described in chapter 6.6. See “Example “Chlorine calibration”” on page 55.

Calibration - Measurement menu field

- 1 Call up the Home menu.
- 2 Tap the desired measurement (e.g. Chlorine).



- 3 Tap the  symbol.



- 4 Press “+” symbol for extended chlorine or pH calibration menu.

- 5 Press "-" symbol for standard calibration menu.
 - 6 Press calibration selection, see "Calibration selection" on page 55.
 - 7 Carry out sensor calibration as described in chapter 6.6. See "Example "Chlorine calibration"" on page 55.
- 3 Press "+" symbol for extended calibration.
 - 4 Press the desired calibration selection. The example here shows chlorine zero point calibration. A further screen opens with information describing the calibration process.

Calibration selection

Chlorine
Zero point: Calibration of the zero point current of the chlorine measurement cell (only if extended calibration selected)
DPD: DPD calibration of the chlorine measurement cell
pH
pH7: pH7 calibration with buffer solution (only if extended calibration selected)
pHX: Span calibration of the pH sensor with buffer solution (only if extended calibration selected)
Offset: Offset calibration of the pH sensor
ORP (Redox)
Cal. value: ORP calibration with buffer solution
Conductivity
Calibration: 60 mS/cm or 600 μ S/cm Calibration with the calibration solution or or comparative measurements
Temp. Offset: Temperature calibration of the integrated temperature sensor in the conductivity sensors
Temperature
Cal. value: Temperature calibration for entry after comparative measurement

Example "Chlorine calibration"

- 1 Call up the Home menu.
- 2 Press the **CAL** menu Calibration in the System menu or the **CAL** symbol in the Measurement menu.



NOTICE

Other calibration selections are performed in a similar way and are not described individually.

- 5 Press the "Calibrate" button to open the input menu.



- 6 Enter the desired values in the input field and save with the Enter key.
- 7 Make any further entries (e.g. DPD).

6.3.3 "Inputs and Outputs" menu

The digital inputs and the mA outputs are configured in this menu.

- 1 Call up the Home menu.
- 2 Tap the symbol.
- 3 Tap the Inputs/Outputs menu.

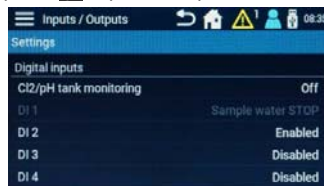

- 4 Press the desired "Digital inputs" or "mA outputs" menu.

Digital inputs
<p>Cl₂/pH tank monitoring: On/Off</p> <p>This parameter is used to switch the min. and empty fill level monitoring for the chlorine and pH tank (acid or alkali). With this function, digital inputs 3 and 4 are used for recording of the tank minimum fill level. Digital input 5 is used as an empty signal input (see Chapter 9. "Wiring diagrams" - Digital inputs). If this function is not used, digital inputs 3 to 5 are freely assignable. When the minimum fill level is reached, an error message appears in the message window. When the empty level is reached, dosing switches off and an error message appears in the message window.</p>
<p>DI 1: Measurement Stop (cannot be changed)</p>
<p>DI 2 / DI 3 / DI 4 / DI 5: Disabled, Enabled, Controller Stop, Standby</p>
<p>mA outputs 1/2/3/4</p>
<p>mA outputs: off, 0 to 20 mA, 4 to 20 mA</p>
<p>Measurement: Chlorine, pH, ORP (Redox), conductivity, temperature</p>
<p>Signal: Measured value, Yout</p>

Explanation of digital input settings:

- **Disabled:** Changes at the digital input have no effect.
- **Enabled:** Changes at the digital input have an effect if they are used in the alarm configuration. Active = contact open at digital input
- **Controller stop:** The controllers switch to Stop (Dosing off) if the digital input is opened (e.g. Circulation off).
- **Standby:** All controllers switch to Dosing off if the digital input is opened. The measured value display is hidden. Standby is used when circulation is switched off and no sample water is flowing through the flow cell.

Example



To transfer a measurement signal, e.g. Chlorine, via the mA output, the following setting is required:

mA output	Settings
mA output	0/40 to 20 mA
Measurement	Chlorine
Signal	Measured value



NOTICE

The settings menus for the mA outputs are only displayed with an installed mA output card.

6.3.4 "Alarm configuration" menu

Alarms 1 to 8 are configured in the "Alarm Configuration" menu. The Ezetrol Touch offers the option of setting various alarm configurations. It is not necessary to assign a relay switching function to every alarm. An alarm can also be used as an alarm message without a relay. The number of available relays that can be used as alarm relays depends on the dosing output. The use of relays for dosing output takes priority. For example, if dosing contact is used as dosing output for chlorine, relay K2 cannot be used as an alarm relay. When the alarms become active, they are displayed in color via the  message symbol and shown in the display area for alarms as an  alarm symbol. Pressing the message symbol opens the message window. Here, the alarm is displayed with time-stamp and description.

Alarms that can be acknowledged can be confirmed by pressing the green Acknowledge button  in the message window.

- 1 Call up the HOME menu.
- 2 Tap the  symbol.
- 3 Tap the  Alarm configuration menu.



- 4 Enter the desired setting.

Alarm 1/2/3/4
Designation: A customer-specific alarm name can be defined. This name is displayed in the message window (main menu) when the alarm becomes active.
Assignment: Assignment of the alarm cause. All min. or max. limit values, digital inputs, errors (general) can be assigned as alarm causes. Multiple assignment is possible.
Acknowledge: Input specifies whether an alarm is defined as an alarm without acknowledgment, an alarm with simple acknowledgment or acknowledgment with Reset.
Delay time: Switch-on delay time.
Relay: disabled/1/2/3/4/5/6
Relay function: Normally Open / N.O Normally Closed / N.C

6.3.5 "Login" menu

Log in on the desired user level in this menu. Depending on the user administration configuration (chapter 6.3.8), three user levels with different rights are available. You can enter either a locking code or a password. The currently logged in user is also displayed in this screen. If the locking code entry is corrected, the pattern is displayed in green. If an incorrect locking code is entered, the pattern is displayed in red. If the user data can no longer be found, please contact your service partner.

- 1 Call up the HOME menu.
- 2 Tap the symbol.
- 3 Tap the Login menu.

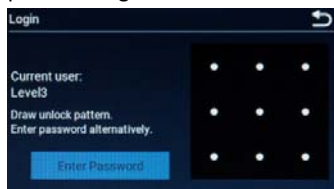

- 4 Enter locking code or password.

6.3.6 "Settings" menu

The device settings not relating to measured values are configured in the Settings menu.

- 1 Call up the HOME menu.
- 2 Tap the symbol.
- 3 Tap the Settings Menu.

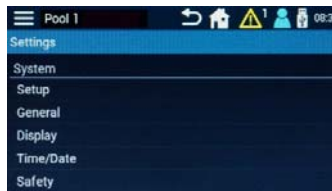

- 4 Enter desired settings.

System
Setup
Setup - Controller
pH control: On/Off Disabled or enabled the pH control function
Conductivity control: On/Off Disabled or enabled the conductivity control function
Setup - Measuring
pH: On/Off Disabled or enabled the pH measurement and control function
ORP: On/Off Disabled or enabled the ORP measurement function (only by installed sensor measuring module redox)
Conductivity: On/Off Disabled or enabled the conductivity measurement function (only by installed sensor measuring module conductivity)
General information
System name: Freely definable
Language: German/English/French/Italian/Croatian/Dutch/Japanese

<p>Hold Function: On/Off The hold function is used to either buffer all measured values or keep them constant during calibration. This prevents the output of invalid control signals by the sensor during the calibration process and also the output of erratic values from measurements via mA-signal and communication interfaces. The function is enabled when the calibration menu is opened and disabled when the menu is closed.</p>	<p>Max. dosing time: 00:00 to 10:00 h The maximum dosing time determines the length of time in which all control outputs must reach their setpoint in the range of the adjusted parameter "Monitoring hysteresis". The controller outputs are switched off after this time. When the setting is "00:00:00," this function is switched off.</p>
<p>Display</p>	<p>Monitoring hysteresis: 2 to 50 % This parameter defines a range around the setpoint for the max. dosing time observation.</p>
<p>Brightness: 0 to 100 %</p>	<p>Safety MAN. mode: Stops dosing with sample water stop or external stop.</p>
<p>Screensaver: Off, 30 s, 1/5/15/30 min, 1 h</p>	<p>Cl2 feed lockout: On/Off If this function is switched on, chlorine dosing switches off automatically if the pH value deviates too far from the pH setpoint. The switch-off limits are defined by the pH setpoint and the parameter "Switch-off range." Example: Setpoint = 7.20 pH Switch-off range = 0.40 pH Chlorine dosing switches off at: pH value > 7.20 + 0.40 = 7.60 pH or pH value > 7.20 - 0.40 = 6.80 pH</p>
<p>Color scheme: Design 1 to 5</p>	<p>pH switch-off range: 0.2 to 1.5 Defines the permissible deviation from the pH setpoint for Cl2 feed lockout activated.</p>
<p>Main display: Standard/narrow Selection of the measurement arrangement in the main display when using the conductivity measurement</p>	<p>User administration (chapter 6.3.8)</p>
<p>Calibrate LED: This setting can be used for white balance of the LED glow stick color if color deviations occur. Red, yellow, blue: 50 to 100 %</p>	<p>Access control: This parameter is used to switch the user administration on and off.</p> <ul style="list-style-type: none"> deactivated = no user administration; all parameters can be changed without entering a password activated = user administration enabled, password protection or Level 1, 2 and 3 can be configured
<p>Time/Date - Date</p>	<p>Level 3: If access control is enabled, as least Level 3 must be used or configured. Level 3 comprises read and write access to all setting parameters of the device.</p>
<p>Time: 00:00 to 24:00 / 00:00 to 12:00</p>	
<p>24 h Format: On/Off</p>	
<p>Safety</p>	
<p>Sample water delay time: 00:00 to 10:00 min The sample water delay time determines the time after which dosing is deactivated, e.g. in the event of sample water Stop. While the delay time is running, "Const." is displayed in the Automatic symbol.</p>	
<p>Feed delay time: 00:00 to 120:00 min The feed delay time delays the start of dosing when the device is switched on, after switch-on, when the operating mode has been changed, after Controller STOP. The rundown of the selected time can be interrupted by selecting the "Start now!" button.</p>	

<p>Unlock pattern: Menu for entry/definition of a Level 3 unlock pattern. The entry must be repeated as confirmation.</p>
<p>Password: Menu for entry/definition of a Level 3 password. The entry must be repeated as confirmation.</p>
<p>Level 2: If access control is enabled, Level 2 can be enabled or disabled. Level 2 allows access to setting parameters such as limit values, setpoint, date, time and calibration. If Level 2 is enabled, an unlocking pattern and/or a password must be defined.</p>
<p>Unlock pattern: Menu for entry of a Level 2 unlock pattern. The entry must be repeated as confirmation.</p>
<p>Password: Menu for entry of a Level 2 password. The entry must be repeated as confirmation.</p>
<p>Level 1: If access control is enabled, Level 1 can be enabled or disabled. Level 1 allows access to calibration. If Level 2 is not enabled, access to limit values and setpoints is also possible on Level 1. If Level 1 is enabled, an unlocking pattern and/or a password must be defined.</p>
<p>Unlock pattern: Menu for entry/definition of a Level 1 unlock pattern. The entry must be repeated as confirmation.</p>
<p>Password: Menu for entry/definition of a Level 1 password. The entry must be repeated as confirmation.</p>
<p>Connection - Network</p>
<p>IP Address: Enter a fixed IP address (contact network administrator)</p>
<p>Subnet mask: Enter the subnet mask (contact network administrator)</p>
<p>Gateway: Gateway settings</p>

<p>DHCP: On/Off In the setting "DHCP = On," the network configuration is automatically defined by the DHCP server and cannot be configured manually. The network settings are displayed. In the setting "DHCP = Off," the network settings must be configured manually.</p>
<p>Status: <input type="checkbox"/> Http <input type="checkbox"/> Modbus</p>
<p>Connection - RS485 interface</p>
<p>Function: Select the RS485 interface function. The RS485 interface supports the bus communication with the Process Monitoring System or other superordinate systems that support the RS485-WT protocol. Various operating modes are integrated to be compatible with old devices. RS485-WT protocol (new address reference list). RS485 PCS plus (1) (address reference list is compatible with the PCS plus 1-address operation) RS485 PCS (3) (address reference list is compatible with the PCS 3-address operation)</p>
<p>Bus address: Bus address setting at the RS485 Interface (RS485 WT) 00 to 31.</p>
<p>Bus address 1/2/3: Bus address setting at the RS485 Interface PCS (3) operating mode for Cl2 (1), pH (2) and ORP (3) 00 to 31</p>
<p>Status: <input type="checkbox"/> RxD <input type="checkbox"/> TxD <input type="checkbox"/> Active <input type="checkbox"/> Error</p>
<p>Backup and Reset</p>
<p>Reset to factory setting: Under Factory setting, the device can be reset to the factory settings. When the factory settings have been restored, the reset settings have to be entered again. You can select which settings are to be reset.</p>
<p>Reset measurement & control parameters: <input checked="" type="checkbox"/> <input type="checkbox"/></p>
<p>Reset system settings: <input checked="" type="checkbox"/> <input type="checkbox"/></p>

Reset user administration:**Reset dosing average:****NOTICE**

To reset the selected setting to the factory setting, press the “Execute” button.

6.3.7 “Information” menu

Various system information, e.g. the installed software version, is described in this menu.

6.3.8 “User administration” menu

The electronics module offers the option of using up to three user levels. Different rights are assigned to each user level. The colored user symbol in the Home screen shows on what level the user is logged in.

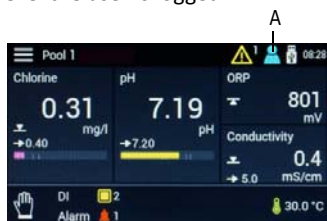

Fig. 2 Home menu

A Actual user administration level

NOTICE

The user administration of the web visualization via Internet browser differs from the user administration on the display of the electronics module (chapter 6.3.9).

No symbol

- User logged out.
- Read rights for all settings and change of operation mode.

NOTICE

No symbols are displayed also with disabled access control; in this case, write access to all settings is possible.

User symbol white = Level 1

- User logged in on Level 1.
- Read rights for all settings, sensor calibration and change of user.

User symbol yellow = Level 2

- User logged in on Level 2.
- Read rights for all settings, sensor calibration, change of operation mode, change limit values and setpoints and change date and time.

User symbol blue = Level 3

- User logged in on Level 3.
- Read rights for and write access to all device settings

NOTICE

In as-delivered status, access control and user administration are switched off. We recommend that you enable access control after commissioning and create the desired users.

Login

- 1 Call up the Home menu.
- 2 Press the symbol.
- 3 Tap the Login menu.
- 4 Enter locking code or password (chapter 6.3.5).

Logout

- 1 Tap the user symbol. The user is logged out and the user symbol is no longer displayed.

Create users

In order to create or change the users, log in on Level 3 is required and access control must be enabled.

- 1 Call up the Home menu.
- 2 Press the symbol.
- 3 Tap the Settings menu.
- 4 Press the “User administration” parameter.

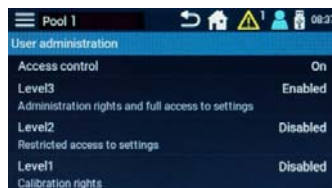

- 5 Set the parameter "Access control" to "On."
- 6 To define or change a password or locking code, the password "3000" (factory setting for Level 3) must be entered.

As an alternative, Level 1 and Level 2 can be enabled. However, this is not mandatory. If Level 1 or Level 2 are not enabled, the device must be operated via the next highest user level.

NOTICE

When access control is disabled, all passwords and locking codes entered are deleted. "3000" is therefore again enabled as the Level 3 password.

- 7 Press the desired parameter Level 1/Level 2 or Level 3 to enable or change the desired Level, 1, 2 or 3. The display changes to the settings menu for the corresponding level (Example: Level 3).

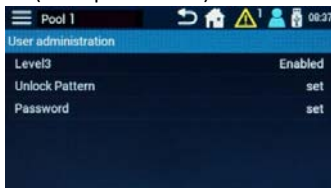

The parameter Level 1/Level 2 or Level 3 is used to enable or disable user level 1,2 and 3. Enter the setting "enabled" to use the Level. After enabling, an unlock pattern and/or password for login must be defined (at least one of these two login options must be set).

To enter an unlock patterns

- 1 Press the "Unlock pattern" parameter.
- 2 Define unlock pattern with the 9 points displayed.
- 3 Press the "Retry" button to correct your entry.
- 4 Press the "Next" button to confirm the entry a second time.
- 5 Enter the same pattern again and save with the "OK" button. The unlock pattern is now set and valid.

To enter a password

- 1 Press the parameter "Password."
- 2 Enter the desired password via the input keypad.
- 3 Confirm with the Enter key.
- 4 Enter the same password again.
- 5 Confirm with the Enter key.
- 6 Press the "OK" button to save the changes. The password is now set and valid.

6.3.9 User administration web visualization

User administration via web visualization comprises two levels. At the factory, these two user levels are disabled and preset to "0." For security reasons, the user levels must be enabled during commissioning. The padlock symbol in the menu bar shows whether the user is logged in. Depending on the specific user, the various menus are shown or hidden.

Padlock symbol red, closed

- User logged out
- Read rights only

Padlock symbol black, open

- User logged in on Level 1 or 2

No padlock symbol

- User administration not enabled

Login

- 1 Press the red padlock symbol. Login window for password entry opens.
- 2 Enter password.
- 3 Confirm with the "Save" button.

Logout

- 1 Press the black padlock symbol. User is logged out.

Enable user levels

- 1 Open "Settings" - "Configure user administration" menu.
- 2 To change/enable the password on Level 1, click the value for the Level 1 password. The input menu opens.
- 3 Enter a combination of numbers and letters with a maximum of ten characters.
- 4 Confirm with the "Save" button.

- 5 To change/enable the password on Level 2, click the value for the Level 2 password. The input menu opens.
- 6 Enter a combination of numbers and letters with a maximum of ten characters.
- 7 Confirm with the "Save" button.

NOTICE

To define or change the passwords at a later time, Login on Level 2 is required. To disable the passwords, define the password as "0".

6.4 Web visualization

The web views integrated in the electronics module allow you to visualize the measurements and setting parameters via a standard browser and Internet-capable devices.



Fig. 3 Example, web view Ezetrol Touch

NOTICE

If alarms or errors are active, a yellow or red message symbol is displayed in the menu bar. Pressing the message symbol displays the active alarms or errors.

The menu bar is divided into two main menus:

- Language
- Settings

6.4.1 Language

Selection of language.

6.4.2 Settings

Parameter
<ul style="list-style-type: none"> • Cl2 free • pH • ORP (Redox) • Conductivity • Temperature
Setpoint: within range
Xp: 1 to 1000
Tn: 0 to 100.0 min
Limit value Max 1: within range
Limit value Min 1: within range
Limit value Max 2: within range
Limit value Min 2: within range
System
System name: Customizable, customer-specific device name
Date: Date setting
Time: 00:00 to 24:00
Software version: Display software version
Software number: Display software number
Serial number: Display device serial number
IP configuration
IP: Enter a fixed IP address (contact the network administrator)
Network mask: Enter the subnet mask (contact the network administrator)
Gateway: Gateway setting
Mac: Display the device Mac address
IP Password: 124 In order to change the IP address of the device via the web visualization, the IP password must first be set to "124."
IP link 1...3: Enter the IP address for up to three devices with the integrated web visualization. These devices can then be called directly from the selection menu (top left of the web view links) via Name of Link 1...3.

Name link 1...3:

Freely configurable menu name for the devices of the IP link 1...3. A maximum of three IP links is possible. This name is displayed in the menu.

Menu IP link

X
Pool 1
Spa
Outdoor pool
Sauna plunge pool

NOTICE

If several Ezetrol Touch devices are connected via the IP link, when entering the IP link, the text “/main.shtml” must be entered after the IP address.

Example: 192.168.200.12/main.shtml

6.5 Firmware update

The firmware for the device is updated using a commercially available USB stick. The memory size must be at least as large as the firmware file itself. For a firmware update, the firmware file “*.SREC” and the file “Bootload.ini” must be copied to the USB stick. Do not use subdirectories.

NOTICE

A firmware update can be downloaded free of charge from the homepage of Evoqua Water Technologies GmbH.

**DANGER****Risk of injury or death!**

External voltages may still be connected even if the operating voltage is switched off.

**WARNING****Risk of injury or damage to the device!**

Only authorized and qualified electricians are permitted to connect the Ezetrol Touch electrically and to open the housing.

- 1 De-energize the electronics module.
- 2 Remove the housing cover of the electronics module.
- 3 Insert the USB stick into the USB port (A).
- 4 Switch on mains voltage.

- 5 Using an insulated screwdriver, briefly press the Update button (B) on the motherboard.

NOTICE

The update takes approximately 1 to 2 minutes. The LED flashes green while the update is in progress. The update is complete when the green LED no longer flashes.

- 6 The USB stick must now be removed.
- 7 Close the housing cover.
- 8 Switch the device on.
- 9 All settings must now be entered again (chapter 5.15).
- 10 Calibrate the sensors.

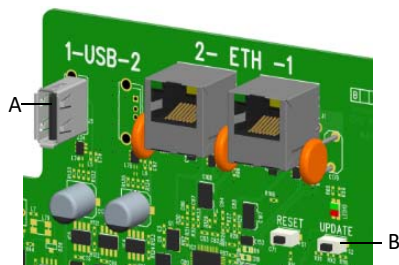

Fig. 4 Section, circuit board

A USB socket

B Update button

6.5.1 LED glow stick color signaling

The color of the LED glow stick switches between white, yellow and red depending on the operating state (chapter 6.3.6).

LED white

- All OK.
- The device is working trouble-free.
- No active errors or currently no message in the message system.

LED yellow

- Alarm that is configured as “unlatched” has been activated. As soon as the cause was rectified and the alarm is inactive, the yellow color signal changes again.
- Fault message became active (only with enabled tank monitoring and if the Min message from the Cl2 or pH tank is present.)

LED red

- Error message present.
- Alarm that is configured with acknowledgment has been activated.

6.6 Calibration

When calibrating the measurements, variations in the calibration solutions, buffer solutions or comparative measurements are adjusted. Calibration is performed for new devices (first commissioning) and to recalibrate existing measuring instruments in accordance with maintenance regulations (chapter 6.3.2 and 5.11.1).

⚠ ATTENTION

Damage to sensor!

Electrodes are highly sensitive! Do not soil or damage! Comply with the safety data sheets for the buffer solutions or calibration solutions.

NOTICE

- Calibration must be carried out on first commissioning.
- The calibration intervals are defined depending on the area of application and water quality.
- Please observe the prescribed maintenance intervals. (chapter 7.1).
- Before calibration of the pH or redox value, the ball valves on the sample water inlet and sample water outlet must be closed and the pressure released.
- Open the ball valves again after calibration.

6.6.1 Chlorine calibration

During calibration for free chlorine, the zero point calibration has to be checked and the measured value calibration (DPD1) must be carried out.



NOTICE

To prevent non-permissible control signals being output during calibration, the "Hold function" in the system menu should be set to "On". mA-outputs and controller outputs then remain constant as long as a calibration menu is open.

Checking the zero point calibration:

- 1 Open the menu "Calibration" – "Chlorine".
- 2 Close the ball valve on the sample water inlet. The measurement value for chlorine should become 0.00 mg/l after 1 to 2 minutes. If not, a zero point calibration needs to be performed.
- 3 Open the ball valve on the sample water inlet.

Zero point calibration

- 1 Press the  symbol.
- 2 Press the  Calibration menu.
- 3 Tap the measurement "Chlorine".
- 4 Press the "+" symbol for extended calibration (zero calibration). If no zero calibration is necessary then continue with DPD calibration (step 11 ff).
- 5 Press the parameter "Zero point".
- 6 Close the ball valve on the sample water inlet.

NOTICE

Make sure that the chlorine sensor is firmly screwed in. Otherwise the measurement accuracy will be affected by inhomogeneous flow and inadequate sand cleaning. When the sample water supply has been stopped, the display first drops rapidly, and after approximately one minute slowly approaches zero. During first commissioning, it is essential to wait for 5 minutes, even if the display shows "0.00" or flashes after a few seconds.

- 7 Wait until the displayed chlorine value no longer changes.
- 8 Press the "Calibration" button. An input field opens.
- 9 Press "Enter" to save the zero point.
- 10 Open the ball valve on the sample water inlet.

Measuring value calibration (DPD)

- 11 After zero point calibration, wait at least 2 minutes.
- 12 Open the sample extraction unit (drain) by approximately 1 turn and extract a specimen of the sample water.
- 13 Determine the content of free chlorine in the sample using a photometer.
- 14 Press the parameter "DPD".



- 15 Press the "Calibration" button. An input field opens.
 - 16 Use the input keys to enter the determined value.
 - 17 Press "Enter" to save the entry.
- This concludes the calibration for free chlorine.

6.6.2 pH calibration

NOTICE

A regularly check of the pH sensor with pH buffer solution is recommended to ensure an exact measurement. If differences are recognized a pH 7 and pH span calibration with pH buffer solutions are recommended.

During pH calibration, the buffer solution and the sample water should have the same temperature. If there is a temperature difference of > 5 °C, first bring the buffer solution to the same temperature as the pool water.

- 1 Press the  symbol.
- 2 Press the  Calibration menu.
- 3 Tap the measurement "pH".
- 4 Press the "+" symbol for extended calibration with pH buffer solutions.
- 5 For pH calibration without buffer solutions use only menu "OFFSET".

pH 7 alignment

- 6 Press the parameter "pH 7".
- 7 Close the sample water inlet and sample water outlet and briefly open the sample extraction unit (drain) to release the pressure. Close the sample extraction unit (drain) again.
- 8 Place the beaker into the bottom clip and fill with buffer solution "pH 7.00" or clamp the bag with buffer solution "pH 7.00" into the bottom clip.
- 9 Unscrew the pH sensor from the cell body cover.
- 10 Dip the pH sensor through the top clip at least 2 cm deep into the buffer solution and move slightly until the indicated pH value remains constant.
- 11 Press the "Calibration" button. An input field opens.
- 12 Use the input field to enter the value to be calibrated for the buffer solution.
- 13 Press "Enter" to save the entry.

pH X-span alignment

NOTICE



If buffer solutions other than those stated are used, the pH value of the buffer solution must be lower than pH 6 or higher than pH 8.

- 14 Remove the buffer solution "pH 7.00" from the bottom clip.
- 15 Wash the sensor in distilled water to prevent carryover of buffer solution.
- 16 Press the parameter "pH X".
- 17 Place the beaker into the bottom clip and fill it with buffer solution "pH 4.65" or clamp a bag with buffer solution "pH 4.65" into the bottom clip.
- 18 Dip the pH sensor at least 2 cm deep into the buffer solution and move gently until the indicated pH value remains constant.
- 19 Press the "Calibration" button. An input field opens.
- 20 Use the keypad to enter the value to be calibrated.
- 21 Press "Enter" to save the entry.
- 22 Remove the pH sensor from the top clip.
- 23 Screw the pH sensor into the cell body cover.
- 24 Open the sample water inlet and outlet again.

The pH measurement has now been calibrated.

Offset compensation

If external influences result in a constant difference between the displayed pH value and a pH value measured manually, this difference can be compensated and the comparative value entered in the Offset menu.

- 1 Press the  symbol.
- 2 Press the  Calibration menu.
- 3 Tap the measurement "pH".
- 4 Press the parameter "Offset".
- 5 Use the keypad to enter the value from the comparative measurement.
- 6 Press "Enter" to save the entry.

This concludes the pH offset.



NOTICE

The offset entry is deleted each time a new pH-7 alignment or span alignment is performed with pH buffer solutions.

6.6.3 ORP calibration (Redox)

NOTICE

ORP (Redox) sensors have long running-in times. This means that after calibration with calibration solution, it can take several hours for the measured value to stabilize.



- 1 Press the  symbol.
- 2 Press the  Calibration menu.
- 3 Select the "ORP" measurement menu.
- 4 Press the parameter "Cal. value".
- 5 Place the beaker into the bottom clip and fill it with calibration solution "478 mV" or clamp a bag with calibration solution "478 mV" into the bottom clip.
- 6 Close the sample water inlet and sample water outlet and briefly open the sample extraction unit (drain) to release the pressure. Close the sample extraction unit (drain) again.
- 7 Screw the ORP sensor into the cell body cover.
- 8 Dip the ORP sensor through the top clip at least 2 cm deep into the calibration solution and move it slightly until the indicated pH value remains constant.
- 9 Press the "Calibration" button. An input field opens.
- 10 Use the keypad to enter the value to be calibrated.
- 11 Press "Enter" to save the entry.
- 12 Remove the ORP sensor from the top clip.
- 13 Screw the ORP sensor into the cover of the cell body of the flow cell.
- 14 Open the sample water inlet and outlet again.

This concludes the ORP calibration.

6.6.4 Conductivity calibration

NOTICE



- Conductivity sensors have no running-in time.
- When calibrating with calibration solution, it must be noted that it takes several minutes for the temperature measurement of the conductivity sensor to become stable.
- Depending on the area of application, use appropriate calibration solution:
Calibration solution 600 $\mu\text{S}/\text{cm}$: conductivity measurement in $\mu\text{S}/\text{cm}$
Calibration solution 60 mS/cm : conductivity measurement in mS/cm
- Furthermore, a measuring range must be set before calibration, which is suitable for calibration solution used:
Calibration solution 600 $\mu\text{S}/\text{cm}$: select measuring range 1000 $\mu\text{S}/\text{cm}$ or 2500 $\mu\text{S}/\text{cm}$.
Calibration solution 60 mS/cm : select measuring range 100 mS/cm or higher.
- Alter calibration, the original measuring range can be adjusted again.

- 1 Press the  symbol
- 2 Tap the  menu.
- 3 Select the "Conductivity" measurement menu.
- 4 Tap the parameter "Calibration."
- 5 Place the beaker into the bottom clip and fill it with calibration solution.
- 6 Close the sample water inlet and sample water outlet and briefly open the sample extraction unit (drain) to release the pressure. Close the sample extraction unit (drain) again.
- 7 Release the clamp connection of the conductivity sensor and remove the conductivity sensor from the cell body cover.
- 8 Dip the conductivity sensor into the calibration solution through the top clip and move it slightly until the indicated pH value remains constant.
- 9 Press the "Calibration" button. An input field opens.
- 10 Use the keypad to enter the value to be calibrate.

- 11 Press "Enter" to save the entry.
- 12 Remove the conductivity sensor from the top clip.
- 13 Screw the conductivity sensor into the cell body cover and tighten the clamp connection.
- 14 Open the sample water inlet and outlet again.
- 15 The conductivity electrode has its own integrated temperature sensor. Variations in the conductivity temperature measurement can be adjusted via the menu Tem.Offset.



This concludes the conductivity calibration.

6.6.5 Temperature calibration

- 1 Press the  symbol.
- 2 Press the  Calibration menu.
- 3 Tap the measurement "Temperature."
- 4 Press the "Cal. value" parameter.
- 5 Perform comparative temperature measurement.
- 6 Use the keypad to enter the value to be calibrated.
- 7 Press "Enter" to save the entry.

This concludes the temperature calibration.

6.7 Messages, alarms and errors

Messages, alarms and errors are displayed on the electronics module with the colored  message symbol. Error messages can occur that can be acknowledged or that can not be acknowledged. If several messages occur at the same time, the number of messages appears next to the symbol. Press the  message symbol to display the message window. Configured alarms, messages that can be acknowledged and errors are displayed as clear text. A time-stamp shows when the message was activated.

6.7.1 Acknowledgeable messages

NOTICE
They are acknowledged via the message window and the green ACK button  .

Error message	Cause	Remedy
Maximum dosing time?	The maximum dosing time set for a control output has been exceeded.	Identify the cause, e.g. chemicals tank empty. Check the dosing pump.
Auto tune error	Auto tune terminated with error.	Chapter 3.5.6.

6.7.2 Non-acknowledgeable messages and errors

NOTICE
Error messages can only be rectified by eliminating the cause.

Error message	Cause	Remedy
Measured value display flashes	Measured value is outside the measurement range.	Check measurement range and change, if necessary. Check dosing or controller settings.
DI 1 flashes	Sample water flow rate recently insufficient (delay time running).	Messwasser-Durchfluss prüfen (ca. 33 l/h). Schmutzfänger reinigen oder wechseln.
DI 1	Sample water flow rate insufficient for some time (delay time elapsed).	Multi-Sensor falsch angeschlossen oder defekt.

Error message	Cause	Remedy
DI 2 DI 3 DI 4 DI 5	Digital input 2 active Digital input 3 active Digital input 4 active Digital input 5 active	Check the cause depending on the use of digital input 2 and 5, e.g. circulation off, remedy fault in the circulation, chemical tank empty, change tank.
Zero point calibration ?	Chlorine sensor: Zero current of sensor > +5 μ A or < -5 μ A	Upot potential voltage set incorrectly; change if necessary. Electrodes of chlorine sensor are dirty, if necessary clean / service. Sample water is not turned off or check valve leaks; turn off sample water if necessary.
DPD calibration ?	Slope error The current difference required for span alignment over the entire measurement range was less than the minimum value. Range: Minimum current difference	Check chlorine sensor. Clean electrodes. Check the pH value of the water (< pH 8).
	Organic chlorine compound (e.g. chlorine stabilizer chloroisocyanurate) in the water.	Do not add any chlorine stabilizers to the water.
	Chlorine sensor: Slope error - the sensor current based on 1 mg/l has fallen below the required minimum.	Clean chlorine sensor, replace cleaning sand.
Conductivity Temperature error ?	Temperature sensor conductivity sensor defective, not connected or incorrectly connected.	Check sensor, wiring or connector.
Module Communication ?	Card of Redox or conductivity sensor is defective.	Check sensor card, if the card is correctly installed.
pH7 calibration ? pHX calibration ? Calibration ? Offset calibration ?	pH: In pH 7 calibration, the sensor signal is outside the range -100 to +100 mV or the sensor issues a signal outside the range 46 to 70 mV per pH increment, the calibration point distance is smaller than 1 pH increment.	Check the electrode. Check buffer solutions, replace if necessary.
	mV: The mV sensor correction offset is outside the range -50 to +50 mV.	Check the electrode. Check calibration solutions, replace if necessary.
	Conductivity: Slope > 1.4 or < 0.6	Offset error in case of a temperature calibration.
Factory calibration ?	Hardware or electronic error	Contact Service.
Setpoint ?	Due to modification of the measurement range, the controller setpoint is outside the range.	Reset the controller setpoint or adjust the measurement range.
Limit value ?	Due to modification of the measurement range, the limit value is outside the range.	Reset the limit value or adjust the measurement range.

Error message	Cause	Remedy
Temperature error ?	Interruption in the temperature sensor or cable of the multi-sensor.	Check multi-sensor and cable.
mA Output 1 ? mA Output 2 ? mA Output 3 ? mA Output 4 ?	Load error The mA output cannot drive its mA output current through the connected current loop (500 ohm at 20 mA max.).	Check whether the mA signal is required at all (e.g. for plotter). If not, switch off the output signal in the "INPUTS/OUTPUTS" menu, "Analog output". Check mA signal cable for interruption.
Hardware ?	Hardware or electronic error	Contact Service.
Data storage ?	Hardware or electronic error	Contact Service.
Cell ?	Chlorine sensor: Chlorine sensor not screwed in. No sand cleaning. Sensor, sensor cable or sensor measuring module defective. Sensor measuring module μ A measuring range exceeded.	Screw in sensor correctly. Check sand cleaning. Check the sensor, sensor cable or sensor measuring module, replace if necessary. Select higher μ A measurement range.
	pH, F ⁻ and mV modules: Sensor, sensor cable or sensor measuring module defective.	Check the sensor, sensor cable and sensor measuring module, replace if necessary.
	Conductivity sensor: Sensor, sensor cable or Sensor-measuring module defective, conductivity to high or too low.	
Cl ₂ feed lockout activated	Deviation of measured pH value from setpoint greater than the set switch-off range (Cl ₂ feed lockout activated).	Check pH dosing
	pH tank may be empty pH measurement may be faulty	Check/replace pH tank Check pH measurement
Auto tune error	see chapter 3.5.6	
Maximum dosing time has been exceeded	The maximum dosing time set for a control output has been exceeded	Check measuring water, calibration, dosing pump, chemical storage sensor, sensor cable, measurement.

6.7.3 Messages

Error message	Cause	Remedy
pH tank level min. reached!	Suction lance pH min. fill level reached	Replace pH tank
Cl ₂ tank level min. reached!	Suction lance Cl ₂ min. fill level reached	Replace Cl ₂ tank
Cl ₂ tank level empty!	Suction lance Cl ₂ empty fill level reached	Replace Cl ₂ tank
pH tank level empty!	Suction lance pH empty fill level reached	Replace pH tank
Sample water	Sample water flow rate too low, dirt filter soiled, sample water inlet or sample water outlet ball valve closed, dirt in inlet, flow control valve or check valve housing.	Open ball valves, clean dirt filter, remove dirt

6.8 Errors and remedies

NOTICE

The table below shows and explains possible faults. If it is not possible to remedy the fault or error yourself, please contact your affiliate.

Error message	Cause	Remedy
No indication on device	No power supply.	Turn external switch or fuse on.
	Device fuse defective.	Check the power supply and replace fuse if necessary (electrician).
Device not showing a measurement.	Sensor measuring module has been changed or added.	Start device again.
Displayed/output value incorrect.	Change on sensor or in the sample water.	Calibrate
Low control quality (controller oscillates, setpoint not reached)	Incorrect controller parameters for Xp or Tn.	Check, adjust controller parameters; perform automatic adaptation on single feedback closed-loop control.
	Dosing chemical tank empty.	Fill, replace.
	Incorrect actuator selected.	Check, correct actuator.
	Positioner or pump defective.	Check, replace positioner/pump.
Measured value display not available, although the appropriate sensor measuring module is installed	Sensor measuring module defective or not installed correctly.	Check, replace sensor measuring module (electrician).
Positioner/pump does not work	Positioner in manual mode.	Engage manual knob.
	Dosing device selected incorrectly.	Select correct dosing device.
	Positioner/pump incorrectly connected.	Connect positioner/pump correctly (electrician).
	Relay defective.	Check (electrician).
	Fuse at relay output defective.	Check (electrician), if necessary, replace fuse and eliminate cause.
Positioner runs in wrong direction	Positioner incorrectly connected.	Correct connections (electrician).
Digital inputs without function	Digital inputs not enabled.	Enable digital inputs, assign function.
Relay switches, but no output.	Relay defective. Fuse on relay defective.	Check (electrician), if necessary, replace fuse.

7. Maintenance

DANGER

Risk of injury or death!

External voltages may still be connected even if the operating voltage is switched off.

NOTICE

Liability for defects can only be accepted if maintenance work is performed as specified. Adhere to the applicable standards and national and regional regulations.

7.1 Maintenance intervals

regularly

- Sample water monitoring (chapter 3.5.7)
- Circulation monitoring (chapter 3.5.7)

daily

- Check the flow cell, including all screw connections, for leakage

weekly

- Check the electrode cleaning sand

every six months

- Replace the electrode cleaning sand

as required

- Clean or replace optional strainer

every 4 to 6 weeks or local standards

- Check ORP (Redox) sensor in calibration solution (instruction manual sensor)
- Check conductivity measurement with comparative measurement and/or calibration solution (instruction manual sensor)

in accordance with standard or local regulations

- Comparative measurement of chlorine and pH, if necessary calibration

5 years

- Replace battery of the electronics module
- Replace battery of the impedance converter

7.2 Maintenance parts set

Part no.	Designation
W3T158874	Maintenance parts kit, annual maintenance
W3T158878	Maintenance parts kit, 4 years
W3T158882	Spare parts set for flow control valve

7.3 Checking for leakage

Check the entire flow cell every day, including all screw connections, for leakage. Repair any leaks immediately.

NOTICE

Ascending air bubbles in the cell body influence the measuring accuracy. The cause must be determined and remedied.

7.4 Checking and replacing the electrode cleaning sand

The electrode cleaning sand is necessary for cleaning the chlorine sensor and must be replenished or replaced if necessary. The electrode cleaning sand must be checked and replaced regularly (chapter 5.11). Grinds itself down with time. Check the flow cell at weekly intervals to make sure that there is enough electrode cleaning sand in the cell body. The electrode cleaning sand must be swirled around in the bottom part of the cell body.

NOTICE

After adding fresh electrode cleaning sand or replacing it, the electrode current can increase slightly for approximately 2 to 3 hours. Calibration is needed after this (chapter 6.6).

7.5 Cleaning the flow rate monitor and check valve

- 1 Switch off the power supply.
- 2 Drain the sample water supply line and drainage line.
- 3 Remove the housing cover of the flow cell.
- 4 Remove the filter unit. To do this, release both knurled nuts.
- 5 Carefully pull the complete check valve housing (A) down and out.
- 6 Turn the check valve housing upside down and catch the flow ball (B) or if the ball is jammed, release it with a slight knock.
- 7 Now use a suitable blunt tool to push out the ball seat (D) and glass ball (C) against the direction of flow.
- 8 Clean the empty check valve housing, flow ball, ball seat and glass ball with clear water.
- 9 During reassembly, make sure that the ball seat and ball are correctly positioned (Fig. 2).
- 10 To help push the assembled check valve housing back into the control valve, we recommend slightly lubricating the gaskets with the Unisilikon grease provided.
- 11 Check that the check valve housing is correctly positioned by the guide lugs on the housing.
- 12 Fit the filter unit again. To do this, tighten the knurled nuts.
- 13 Fit the housing cover.
- 14 Connect the sample water supply line and drainage line again.
- 15 Reconnect the power supply.

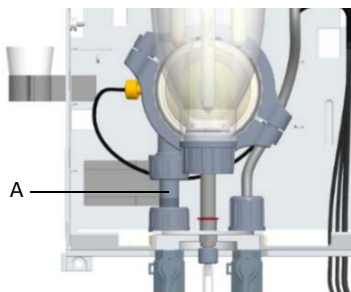

Fig. 1 Section, installation position of the check valve housing

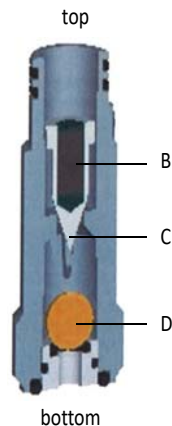

Fig. 2 Cross-section of the check valve housing

- A Check valve housing (overall view)
- B Flow ball
- C Ball seat
- D Glass ball

7.6 Cleaning or replacing the optional strainer

The optional strainer must be cleaned or replaced regularly to avoid contamination or blockages. The frequency of cleaning or replacement depends on the degree of contamination caused by the sample water.

- 1 Close the ball valve on the sample water supply line in front of the strainer.
- 2 Unscrew the strainer and rinse it with water. Catch escaping water in a container.
- 3 Remove the strainer screen and rinse it under running water or replace it.
- 4 Fit the strainer screen again and reinstall the strainer.
- 5 Open the ball valve on the sample water supply and drainage line again.

7.7 Replacing the fuses on the CPU board

WARNING

Risk of injury or damage to the device!

Only authorized and qualified electricians are permitted to install the Ezetrol touch and open the housing.

The mains input and all relays are protected by fuses of type TR5. 3.15 A (slow-blow) fuses are used for the relays and 1.6 A (slow-blow) fuses for the mains input. Spare fuses are included with the accessories.

- 1 Disconnect the electronics module from the power supply and check that it is de-energized.
- 2 Remove the housing cover of the electronics module.
- 3 Pull the defective fuse (A) out of the fuse holder and insert new fuse, making sure that the rated data match!
- 4 Fit the housing cover.

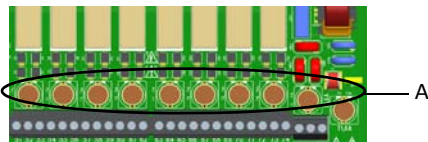

Fig. 3 Section, electronics module - fuses

A Fuses

7.8 Replacing the battery

WARNING

Risk of injury or damage to the device!

Only authorized and qualified electricians are permitted to install the Ezetrol touch and open the housing.

The battery is required for the real time clock in case of a power failure. If the time is not correct or if time-controlled functions show faulty behavior, the battery must be changed. After five years at the latest.

- 1 Disconnect the electronics module from the power supply.
- 2 Remove the housing cover of the electronics module. Unscrew the housing cover and remove it carefully. Hook into holder on the basic housing.
- 3 Remove the battery from the holder.

ATTENTION

Environmental hazard!

Do not throw away or burn batteries. The batteries must be disposed of in accordance with environmental protection regulations.

- 4 Insert the new battery, type CR2032.
- 5 Fit the housing cover.
- 6 Switch on mains voltage.
- 7 Set date and time, no other settings need to be made.

NOTICE

No further adjustments need to be made.

7.9 Cleaning

Never use corrosive cleaning agents (e.g. spirit, scouring agents)! We recommend that you use a moist cloth with a neutral household cleaning agent.

8. Spare parts, Accessories and Retrofit kits

NOTICE

For reasons of safety, only use original spare parts. Please contact our customer service if you need any spare parts.

8.1 Electronics module (module name E02)

Part No.	Designation
W3T400910	Electronics module for Cl2/pH, spare part
W3T399966	CPU-board (motherboard spare part)
W3T400909	Operating front panel with cover and display
W3T160551	M20x1.5 hex nut
W2T504179	M20x1.5 cable gland
W2T504212	M20 blind plug
W3T160552	M25x1.5 hex nut
W2T542498	M25x1.5 cable gland for assembly of cables with pre-assembled connectors
W2T833447	Cable gland M20 for sensor cable
W3T172625	Lithium coin cell battery CR2032
W2T821593	RJ45 connection cable CPU-board/HMI
W2T839300	Fuse TR5 3,15A T
W2T839299	Fuse TR5 1,6A T
W3T364410	Sensor cable for chlorine sensor
W3T173161	Sensor cable for pH sensor
W3T173161	Sensor cable for ORP sensor
W3T172050	Sensor cable for conductivity sensor
W3T391866	LED glow stick
W3T391865	4-way mA output card
W3T391864	Sensor card for ORP sensor
W3T364409	Multi-sensor
W2T505559	RS485 data cable (1 m)
W3T434450	Sensor card for conductivity measurement

8.2 Flow cell (module name D02)

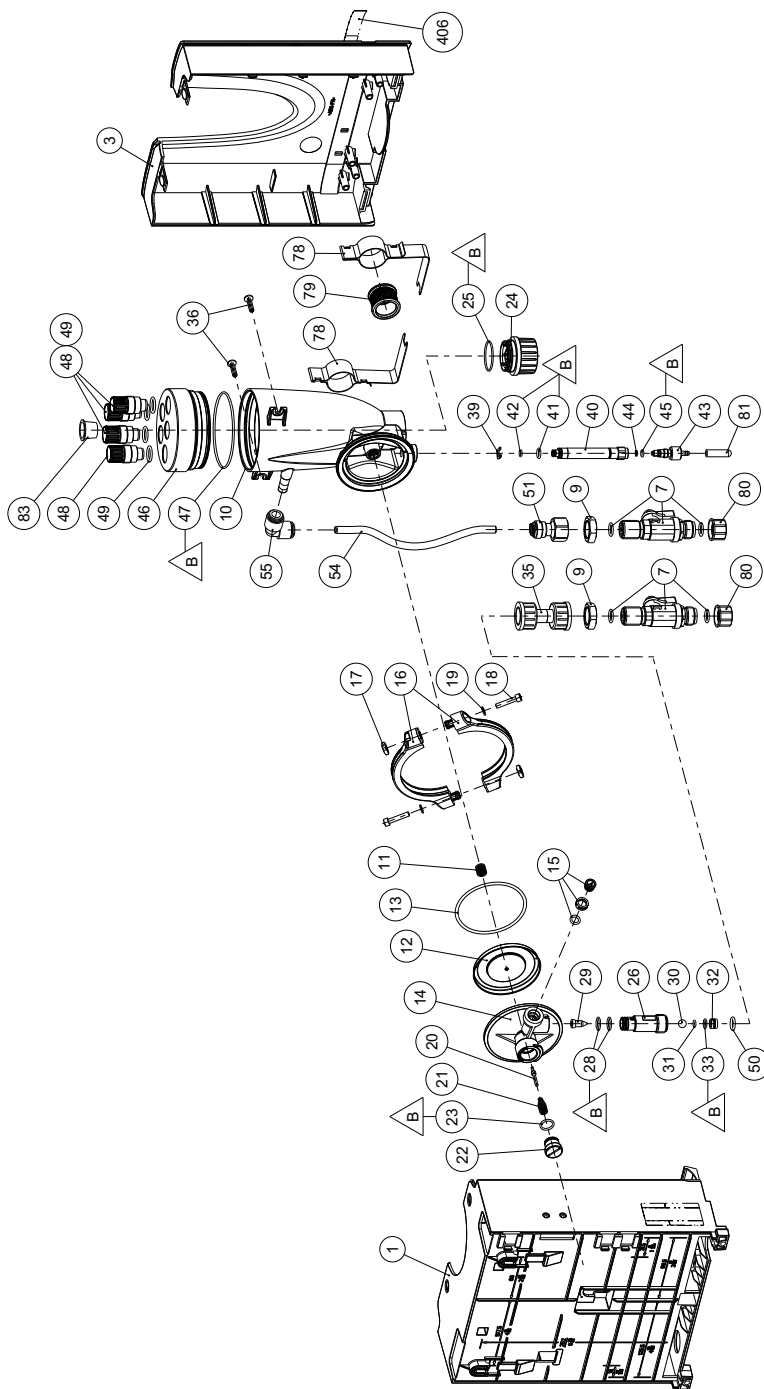

B	O-Ring leicht gefettet mit Spezialfett UNISILIKON L250L (W2T504248/W2T504249) Grease the o-rings slightly with special grease UNISILIKON L250L (W2T504248/W2T504249) Graisser les joint toriques légèrement avec UNISILIKON L250L (W2T504248/W2T504249)
---	---

Item	Part No.	Designation
1	W3T247776	Basic housing
2	W2T507548	Type plate
3	W3T247777	Housing cover
7	W3T166170	Shut-off valve
9	W2T507615	Flat nut
10	W3T158559	Cell body
11	W3T164226	Compression spring
12	W3T158569	Membrane unit
13	W3T160654	O-ring
14	W3T158595	Control valve body
15	W2T504209	Plastic cartridge
16	W3T160649	V profile clamp
17	W3T158567	Square nut
18	W2T504659	Cheese-head screw
19	W2T506019	Washer
20	W3T158572	Valve pin
21	W3T172795	Compression spring
22	W3T158573	Adjusting screw
23	W3T160357	O-ring
24	W3T160650	Flow distributor cap
25	W3T160655	O-ring
26	W3T160648	Check valve housing
28	W3T161396	O-ring
29	W3T169827	Cone
30	W3T172946	Ball
31	W3T172949	O-ring
32	W3T159707	Insert
33	W3T172975	O-ring
35	W3T158602	Filter unit
36	W2T505463	Pan head screw
39	W3T172041	Securing ring
40	W3T158576	Outlet drain pipe
41	W3T172997	O-ring
42	W3T164597	O-ring
43	W3T158575	Drain screw
44	W3T166160	EPDM flat gasket
45	W3T172556	O-ring
46	W3T320101	Cell body cover
47	W3T160657	O-ring

Item	Part No.	Designation
48	W3T161450	Plug
49	W3T168859	O-ring
50	W3T172861	O-ring
51	W2T863568	Adapter
54	W3T438413	Hose
55	W2T505093	Angle-reducing connector
78	W3T166169	Clip
79	W3T172045	Electrode mount
80	W3T161561	Screw cap
81	W3T168162	Protective cap
83	W3T161453	Protection plug
406	W3T341070	Empty strips

8.3 Cell body, flow cell

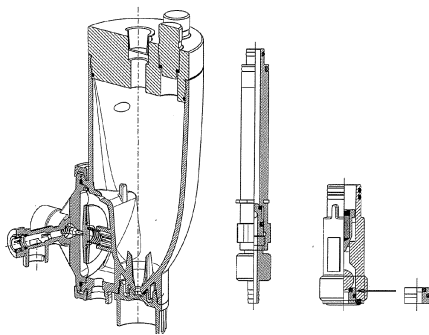

Item 1 Item 2 Item 3 and 4

Pre-installed assembly groups

Item	Part No.	Designation
1	W3T320116	Cell body, fully pressurized version
2	W3T166171	Sample extraction unit
3	W3T158603	Back pressure unit with float
4	W3T163739	Spherical set cpl.

8.4 Sensors and extension cables

NOTICE

When disinfecting with inline electrolysis systems or hydrogen drainage into the pool water, the gold version of the chlorine or ORP (Redox) sensor must be used.

Designation	Chlorine sensor (free chlorine)	pH sensor	ORP (Redox) sensor	Conductivity sensor LF325
Sensor	-	W3T169297	-	W3T172052
Platinum version	W3T160652	-	W3T169298	-
Gold version	W3T160991	-	W3T172356	-
KCl tank with stand and 5 ml KCl solution		W3T164482		-
Electrolyte solution 3 mol/l KCl, bottle 250 ml		W3T160410		-
Electrode cleaning sand, white	W3T171317	-	-	-
Buffer solution pH 7.00				
Bottle 250 ml	-	W3T165076	-	-
Bag 12 ml	-	W3T161181	-	-
Buffer solution pH 4.65				
Bottle 250 ml	-	W3T165084	-	-
Bag 12 ml	-	W3T161189	-	-
Calibration solution 478 mV				
Bottle 250 ml	-	-	W3T165048	-
Bag 12 m	-	-	W3T161182	-
Calibration solution 60 mS/cm				
Bottle 250 ml	-	-	-	W3T427608
Bottle 1000 ml	-	-	-	W3T161187
Calibration solution 600 µS/cm				
Bottle 250 ml	-	-	-	W3T427609
Bottle 1000 ml	-	-	-	W3T161179
Measuring beaker (5 pieces)			W3T158600	

Extension cable	Chlorine sensor (with 1 connector)	pH sensor (with 2 connector)	ORP (Redox) sensor (with 2 connector)	Conductivity sensor (with 2 connector)
5 m	W3T164515		W3T164517	
10 m	W3T164516		W3T164518	
15 m	W3T164547		W3T164544	
25 m	W3T164548		W3T164545	
50 m	W3T164549		W3T164546	

8.5 Accessories

Part-Nr.	Designation
W3T165563	Impedance converter for pH or ORP sensor
W3T158721	Strainer with ball valve, straight
W3T389201	Set of fittings for strainer

Metric PVC tubing, fabric-reinforced (internal diameter x wall thickness)	ø 4 x 3	ø 6 x 3	ø 10 x 3
Tubing	W2T505524	W2T505525	W2T505334
PVC hose connecting parts comprising:	W3T167626	W3T167518	W3T167590
O-ring	W3T172861	W3T172861	W3T169068
Locking ring	W3T163417	W3T161436	W3T159622
Union nut	W3T161502	W3T161502	W3T167297
Hose bushing	W3T172945	W3T161501	W3T167293

Metric PE tubing (internal diameter x wall thickness)	ø 4 x 1	ø 6 x 1	ø 6 x 2	ø 10 x 2
Tubing	W2T507155	W2T505784	W2T505676	W2T505734
PVC hose connecting parts comprising:	W3T163752	W3T171453	W3T163796	W3T163825
O-ring	W3T172861	W3T172861	W3T172861	W3T169068
Locking ring	W3T172891	W3T169815	W3T163436	W3T163437
Union nut	W3T161502	W3T161502	W3T161502	W3T167297
Hose bushing	W3T172945	W3T161501	W3T161501	W3T167293

8.6 Retrofit kits/extensions

Part no.	Designation
W3T391868	Sensor measuring module ORP comprising: ORP sensor card, ORP sensor, sensor cable, calibration solution
W3T434521	Sensor measuring module conductivity 60 mS/cm comprising: conductivity sensor card, conductivity sensor (LF325), sensor cable, calibration solution 60 mS/cm and terminal strip
W3T434592	Sensor measuring module conductivity 600 μ S/cm comprising: conductivity sensor card, conductivity sensor (LF325), sensor cable, calibration solution 600 μ S/cm and terminal strip
W3T391865	4-way mA output card, terminals

9. Wiring diagram

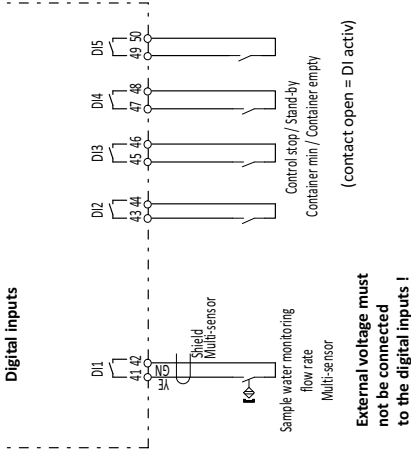

WAE9686 - Issue 07-1119

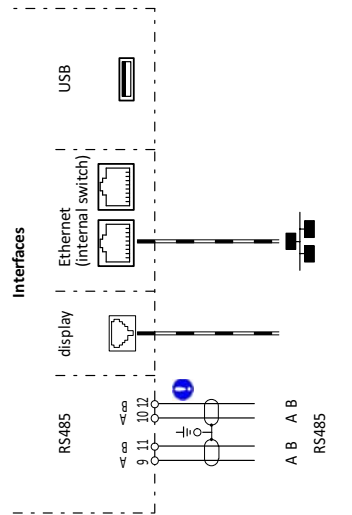
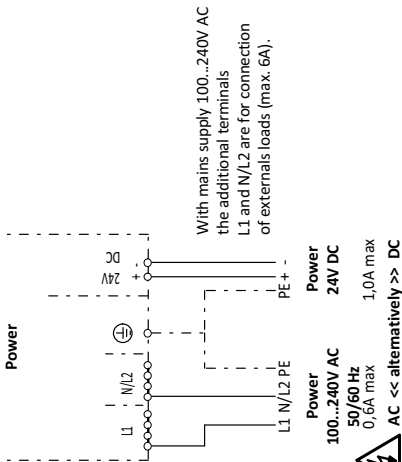
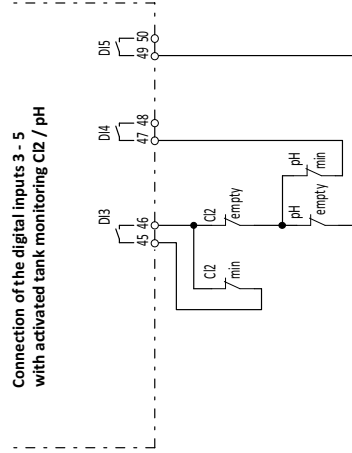

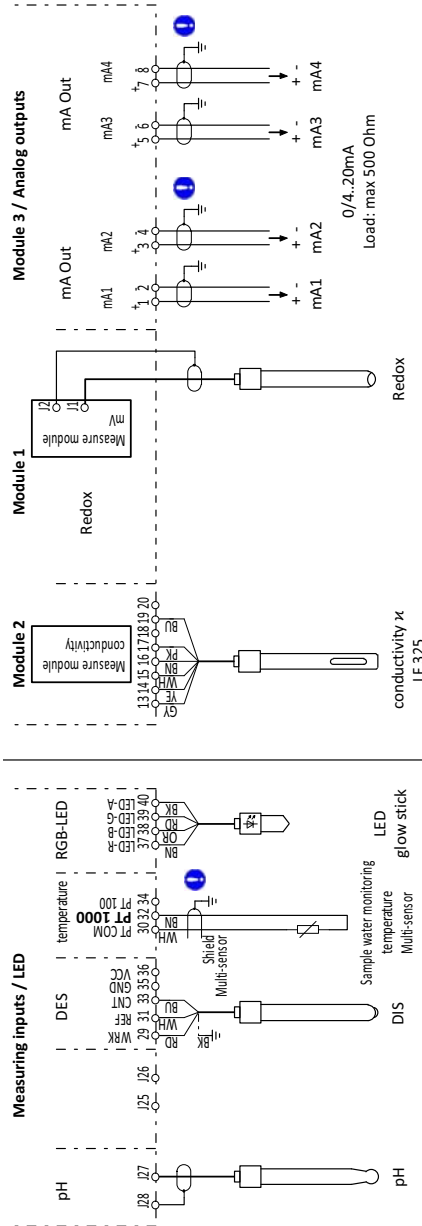

Note

Observe permissible contact load!
See chapter Relay outputs and technical data.

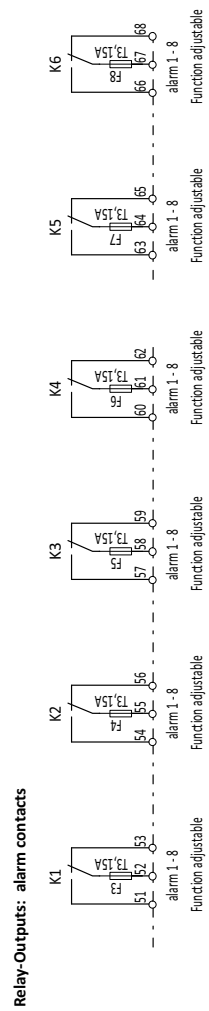

The Relay K1, K2, K3 and K4 are only available as alarm contacts if they are not used as control or dosing outputs!

External voltage may still be connected even when the main switch is set to OFF!



Observe Note 1

Relay-Outputs: Dosing Chlorine

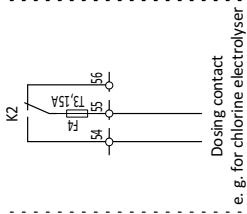
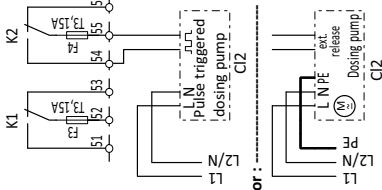
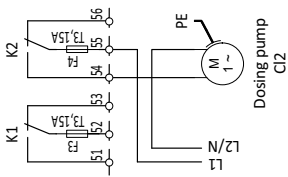
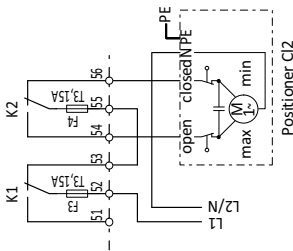

Note
Observe permissible contact load!
See chapter Relay outputs and technical data.

External voltage may still be connected even when the main switch is set to OFF!

Dosing contact
e. g. for chlorine electrolyser

Observe Note 1

Observe Note 1

Observe Note 1

Relay-Outputs: Dosing pH

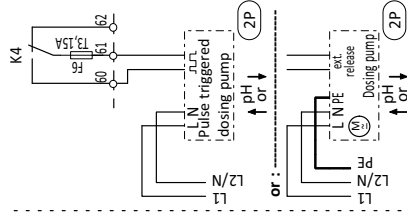
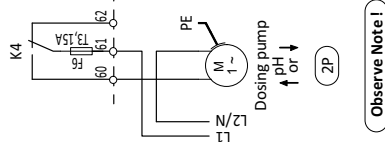
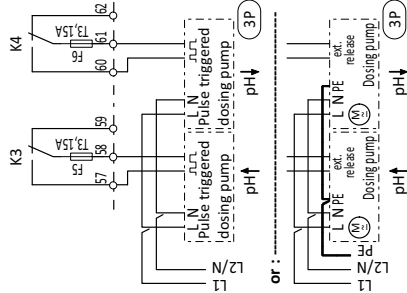
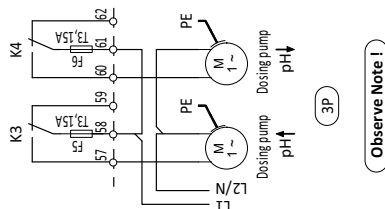
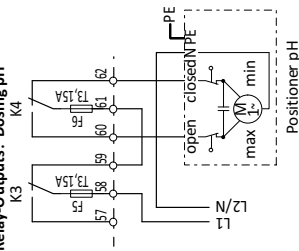

Dosing contact
pH ↑
or
pH ↓

Observe Note 1

Observe Note 1

Observe Note 1

Observe Note 1

Relay-Outputs: Dosing conductivity

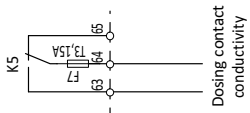
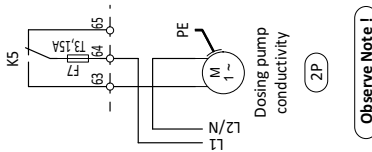
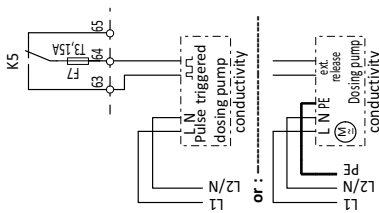

Note

Observe permissible contact load!
See chapter Relay outputs and technical data.

External voltage may still be connected even when the main switch is set to OFF !

10. EC Declaration of Conformity and Certificate



EG-Konformitätserklärung EC Declaration of Conformity Déclaration CE de conformité

No. MAE1839

Ausgabe/issue/édition 01

Hersteller/Manufacturer/Constructeur: Evoqua Water Technologies GmbH

Anschrift/Address/Adresse: Auf der Weide 10, D-89312 Günzburg

Produktbezeichnung: Mess-, Regel- und Dosiersystem Ezetrol® touch
Product description: bestehend aus: Elektronik-Modul (E02) und Durchfluss-Modul (D02)
Description du produit: *Measuring, control and dosing system Ezetrol® touch comprising: Electronics module (E02) and flow cell (D02)*
Dispositifs de mesure, regulation et de dosage Ezetrol® touch comprenant : *Module électronique (E02) et module de la cellule de mesure (D02)*

Das bezeichnete Produkt stimmt in der von uns in Verkehr gebrachten Ausführung mit den Vorschriften folgender europäischer Richtlinien überein:

The product described above in the form as delivered is in conformity with the provisions of the following European Directives:

Le produit désigné est conforme, dans la version que nous avons mise en circulation, avec les prescriptions des directives européennes suivantes :

- 2014/30/EU Richtlinie des Europäischen Parlaments und des Rates vom 26. Februar 2014 zur Harmonisierung der Rechtsvorschriften der Mitgliedstaaten über die elektromagnetische Verträglichkeit.
Directive of the European Parliament and of the Council of 26 February 2014 on the approximation of the laws of the Member States relating to electromagnetic compatibility.
Directive du Parlement européen et du Conseil du 26 février 2014 relative au rapprochement des législations des Etats membres concernant la compatibilité électromagnétique.
- 2014/35/EU Richtlinie des Europäischen Parlaments und des Rates vom 26. Februar 2014 zur Harmonisierung der Rechtsvorschriften der Mitgliedstaaten betreffend elektrische Betriebsmittel zur Verwendung innerhalb bestimmter Spannungsgrenzen.
Directive of the European Parliament and of the Council of 26 February 2014 on the harmonisation of the laws of Member States relating to electrical equipment designed for use within certain voltage limits.
Directive du Parlement européen et du Conseil du 26 février 2014 concernant le rapprochement des législations des Etats membres relatives au matériel électrique destiné à être employé dans certaines limites de tension.
CE-Kennzeichnung / CE marking / Marquage CE: 2017



Die Konformität mit den Richtlinien wird nachgewiesen durch die Einhaltung der in der Nachweisdokumentation aufgelisteten Normen.

Evidence of conformity to the Directives is assured through the application of the standards listed in the relevant documentation.

La conformité avec les directives est assurée par le respect des normes listés dans la documentation technique correspondante

Benannte Person für technische Unterlagen:

Authorized person for the technical file:

Personne désignée pour la documentation technique:

Name / name / nom: Evoqua Water Technologies GmbH

Adresse / address / adresse: Auf der Weide 10, D-89312 Günzburg

Günzburg, den / the 2017-07-12

Evoqua Water Technologies GmbH

Klaus Andre
Technischer Leiter / Director Engineering

Unterschrift
signature / signature

Helmut Fischer
Leiter QM / Quality Manager

Unterschrift
signature / signature

Diese Erklärung bescheinigt die Übereinstimmung mit den genannten Richtlinien, ist jedoch keine Beschaffenheits- oder Haltbarkeitsgarantie nach §443 BGB. Die Sicherheitshinweise der mitgelieferten Produktdokumentation sind zu beachten.

This declaration certifies the conformity to the specified directives but does not imply any warranty for properties. The safety documentation accompanying the product shall be considered in detail.

La présente déclaration atteste de la concordance avec les directives citées, elle n'offre cependant pas de garantie quant à la nature ou la durabilité selon l'article 443 du code civil allemand. Les consignes de sécurité de la documentation du produit fournie sont à respecter.

Wallace & Tiernan® Products worldwide

Australia

+61 1300 661 809
info.au@evoqua.com

Canada

+1 905 944 2800
wtoc.can@evoqua.com

China

+86 21 5118 3777
sales.cn@evoqua.com

France

+33 1 41 15 92 20
wtfra@evoqua.com

Germany

+49 8221 9040
wtger@evoqua.com

Singapore

+65 6559 2600
sales.sg@evoqua.com

UK

+44 300 124 0500
info.uk@evoqua.com

USA

+1 800 524 6324
wt.us@evoqua.com

